

**OLYMPUS<sup>®</sup>**

---

**DIGITAL VOICE  
RECORDER**

**DS-5000  
DS-5000iD**

**DETAILED  
INSTRUCTIONS**

Thank you for purchasing an Olympus  
Digital Voice Recorder.

Please read these instructions for information  
about using the product correctly and safely.

Keep the instructions handy for future reference.

---

To ensure successful recordings, we recommend that  
you test the record function and volume before use.

**EN**

# Introduction

- The contents of this document may be changed in the future without advanced notice. Contact our Customer Support Center for the latest information relating to product names and model numbers.
- The utmost care has been taken to ensure the integrity of the contents of this document. In the unlikely event that a questionable item, error, or omission is found, please contact our Customer Support Center.
- Any liability for passive damages or damage of any kind occurred due to data loss incurred by a defect of the product, repair performed by the third party other than Olympus or an Olympus authorized service station, or any other reasons is excluded from the Olympus's liability.

## Trademarks

Microsoft and Windows are registered trademarks of Microsoft Corporation.

Macintosh is a trademark of Apple Inc.

Intel and Pentium are registered trademarks of Intel Corporation.

SD and microSD are trademarks of SD card Association.

SDHC and microSDHC are trademarks of SD card Association.

Other product and brand names mentioned herein may be the trademarks or registered trademarks of their respective owners.



# INDEX

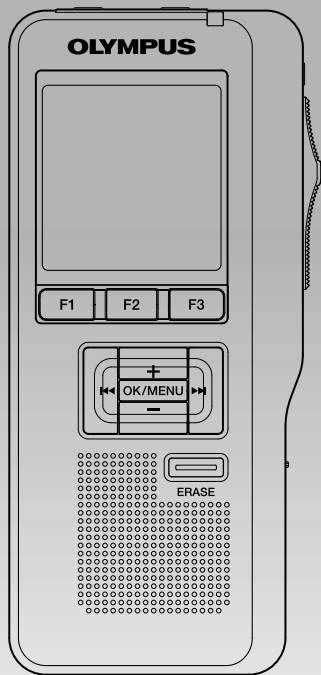

---

**Table of Contents** P.4

---

**Safe and Proper Usage** P.6

**Getting Started** P.11

**Basic Operations** P.27

**Advanced Operations** P.41

**Managing Files on Your PC** P.69

**Other Practical Use Methods** P.77

**Other Information** P.78

**1**

**2**

**3**

**4**

**5**

**6**

# Table of Contents

|                             |   |
|-----------------------------|---|
| Table of Contents .....     | 4 |
| Safe and Proper Usage ..... | 6 |
| General Precautions .....   | 7 |

## 1 Getting Started

|                                                      |    |
|------------------------------------------------------|----|
| Main Features .....                                  | 11 |
| Memory Card .....                                    | 12 |
| Identification of Parts .....                        | 14 |
| Installing Batteries .....                           | 16 |
| Charging Battery Pack .....                          | 18 |
| Using the Battery Pack .....                         | 20 |
| Using the AC Adapter .....                           | 21 |
| Turning ON the Recorder .....                        | 22 |
| Power Save Mode (Power Save) .....                   | 22 |
| Inserting and Ejecting a SD card .....               | 23 |
| Setting Time and Date (Time & Date) ...              | 24 |
| Setting Recording Destination<br>(Card Select) ..... | 26 |

## 2 Basic Operations

|                                                           |    |
|-----------------------------------------------------------|----|
| Recording .....                                           | 27 |
| Microphone Sensitivity (Mic Sense) .....                  | 31 |
| Recording Modes (Rec Mode) .....                          | 32 |
| Using the Variable Control Voice Actuator<br>(VCVA) ..... | 33 |
| Hands-free Recording .....                                | 34 |
| Recording Monitor .....                                   | 34 |
| Playing .....                                             | 35 |
| Erasing .....                                             | 37 |

## 3 Advanced Operations

|                                            |    |
|--------------------------------------------|----|
| Menu List .....                            | 41 |
| Learning to Use the Menu .....             | 43 |
| Selecting Folders and Files .....          | 44 |
| Displaying File Information .....          | 45 |
| Device Lock Function .....                 | 46 |
| Locking Files (Lock) .....                 | 50 |
| Pending Files (Pending) .....              | 51 |
| Setting Priority Levels (Priority) .....   | 52 |
| Setting the Author ID and Work Type ....   | 53 |
| Verbal Comment .....                       | 56 |
| Index Marks .....                          | 57 |
| Language (Language) .....                  | 58 |
| Backlight (Backlight) .....                | 59 |
| LED (LED) .....                            | 60 |
| LCD Contrast Adjustment (Contrast) ....    | 61 |
| System Sounds (Beep) .....                 | 62 |
| Inserting and Ejecting a microSD card .... | 63 |
| Formatting the Card (Format) .....         | 64 |
| Check System Information (System info.) .. | 66 |
| Changing the USB Class (USB Class) ....    | 67 |
| Customizing the Recorder .....             | 68 |

## 4 Managing Files on Your PC

|                                        |    |
|----------------------------------------|----|
| DSS Player Software .....              | 69 |
| Installing DSS Player Software .....   | 71 |
| Uninstalling DSS Player Software ..... | 72 |
| Using Online Help .....                | 73 |
| Connecting Recorder to PC .....        | 74 |
| Running DSS Player Software .....      | 76 |

## **5 Other Practical Use Methods**

Using as External Memory of the Computer ... 77

## **6 Other Information**

|                                        |    |
|----------------------------------------|----|
| Alarm Message List .....               | 78 |
| Troubleshooting .....                  | 79 |
| Accessories .....                      | 80 |
| Specifications .....                   | 81 |
| Technical Assistance and Support ..... | 82 |

# Safe and Proper Usage

Before using your new recorder, read this manual carefully to ensure that you know how to operate it safely and correctly. Keep this manual in an easily accessible location for future reference.

## Important Safety Precautions

Certain symbols are used in the user's manual and on this product to help protect users, their surroundings, and their property from possible injury or damage. Please familiarize yourself with the following definitions and meanings for each symbol before reading the precautions.



**Danger**

Signifies danger which may result in serious injury or death.



**Warning**

Indicates items or actions which may cause serious injury or death.



**Caution**

Indicates items or actions which may result in damage or personal injury.

## Symbols prohibiting a specific action



**Prohibited**



**Do not disassemble**

## Symbols requiring a specific action



**Mandatory**



**Unplug from power outlet**

## Convention Used In this Manual

- The word “card” is used to refer to the SD card and microSD card.
- The word “DSS Player” is used to refer to the DSS Player Pro R5 Dictation Module in Windows environment and DSS Player in Apple Macintosh environment.
- The Notes at the bottom of a page are used for additional information, exceptions, or related events.
- Words in uppercase form such as PLAY or REC are used to describe a function, button, or switch position on the recorder.

# General Precautions

---

- Do not leave the recorder in hot, humid locations such as inside a closed automobile under direct sunlight or on the beach in the summer.
- Do not store the recorder in places exposed to excessive moisture or dust.
- Do not use organic solvents such as alcohol and lacquer thinner to clean the unit.
- Do not place the recorder on top of or near electric appliances such as TVs or refrigerators.
- Avoid recording or playing back near cellular phones or other wireless equipment, as they may cause interference and noise. If you experience noise, move to another place, or move the recorder further away from such equipment.
- Avoid sand or dirt. These can cause irreparable damage.
- Avoid strong vibrations or shocks.
- Do not disassemble, repair or modify the unit yourself.
- Do not operate the unit while operating a vehicle (such as a bicycle, motorcycle, or go-cart).
- Keep the unit out of the reach of children.

## <Warning regarding data loss>

Recorded content in memory may be destroyed or erased by operating mistakes, unit malfunction, or during repair work.

It is recommended to back up and save important content to other media such as a computer hard disk.

## Batteries/Rechargeable Battery Pack

### Danger

- Do not solder lead wires or terminals directly onto a battery or modify it.
- Do not connect the ⊕ and ⊖ terminals together. This may cause fire, overheating or electric shock.
- When carrying or storing the battery, be sure to put it in the provided case to protect its terminals. Do not carry or store the battery with any metal objects (such as key rings). If this warning is not followed, fire, overheating or electric shock may occur.
- Do not connect the batteries directly to a power outlet or a cigarette lighter of an automobile.
- Do not insert the batteries with their ⊕ and ⊖ terminals reversed.
- If any liquid from a battery gets into your eyes, promptly wash it off with clean water and consult your doctor at once.
- There is a hole from which gas escapes on the ⊕ terminal. Do not cover or block it.

### Warning

- Batteries should never be exposed to flame, heated, short-circuited or disassembled.
- Do not attempt to recharge alkaline, lithium or any other non-rechargeable batteries.
- Never use any battery with a torn or cracked outer cover.
- Keep batteries out of the reach of children.

**If you notice anything unusual when using this product such as abnormal noise, heat, smoke, or a burning odour:**

- ① remove the batteries immediately while being careful not to burn yourself, and;
  - ② call your dealer or local Olympus representative for service.
- Do not expose the rechargeable batteries to water. Do not allow water to contact the terminals.
  - Do not remove or damage the battery insulating sheet.
  - Do not use the batteries if you find something wrong with them such as leakage, color change or deformity.
  - Unplug the charger if the charging is still incomplete after the specified time it should take.
  - Should any battery liquid get on skin or clothing, promptly wash it off with clean water.
  - Keep batteries away from fire.

**⚠ Caution**

- Rechargeable batteries are exclusively for use with Olympus digital voice recorder DS-5000/5000iD. Do not use them in combination with other equipment.
- Do not subject batteries to strong shocks.
- Do not use batteries of different types, voltages, and/or brand names.
- When using rechargeable batteries or battery pack, make sure they are charged at the same time.
- When using rechargeable batteries or battery pack that have not been used for a while, be sure to recharge them before use.

## Cradle

---

**⚠ Danger**



- Never disconnect the AC adapter or power cord with a wet hand. This may cause electric shock or injury.



- Only use the included AC adapter with the cradle. Using it in combination with other AC adapters may cause overheating, fire, or malfunction.

**⚠ Warning**



Do not disassemble

- Never disassemble, modify, or repair the recorder yourself. This may cause fire, electric shock, or injury.



- Never use it in locations where it might come into contact with water (such as a bathroom). Getting the recorder wet may cause fire or electric shock.



- Do not drop the recorder or allow it to suffer a shock. This may cause damage, fire, or electric shock.



- Do not insert metal wires or similar objects. This may cause fire, overheating or electric shock.



- Keep out of the reach of children. Do not let children use this product without adult supervision.



### Caution



- Do not use or store the Cradle in/ on an unstable place, such as a television set, etc. If it falls, it may cause injury or break.



Unplug from power outlet

- Unplug the AC adapter or power cord from the cradle and AC outlet when not using for extended periods of time. If this precaution is not followed and the cradle is damaged then fire may occur.

### AC Adapter

---

### Danger



- Be sure to use the AC Adapter with the proper voltage (AC 100 - 240 V). Using it with other voltage levels may cause fire, explosion, overheating, electric shock or injury.



Unplug from power outlet

- For safety, be sure to unplug the AC Adapter from the outlet before performing maintenance or cleaning. Also, never plug in or disconnect the power plug with a wet hand. This may cause electric shock or injury.

### Warning

- Do not attempt to disassemble, repair or modify the AC adapter in any way.
- Keep foreign objects including water, metal, or flammable substances from getting inside the product.
- Do not moisten the AC adapter or touch it with a wet hand.
- Do not use the AC adapter in the vicinity of flammable gas (including gasoline, benzene and lacquer thinner).

### In case

- ... the internal parts of the AC adapter are exposed because it has been dropped or otherwise damaged:
- ... the AC adapter is dropped in water, or if water, metal flammable substances or other foreign objects get inside it:
- ... you notice anything unusual when using the AC adapter such as abnormal noise, heat, smoke, or a burning odour:
  - ① do not touch any of the exposed parts;
  - ② immediately disconnect the power supply plug from the power outlet, and;
  - ③ call your dealer or local Olympus representative for servicing. Continued use of the AC adapter under these circumstances could result in electric shock, fire or injury.

### Caution



- Do not use the AC Adapter if the power plug is damaged or the plug is not completely connected to the outlet. This may cause fire, overheating, electric shock, short circuit or damage.
- Unplug the AC Adapter from AC outlet when not using. If this precaution is not followed, fire, overheating or electric shock may occur.



Unplug from power outlet



- Make sure to hold the plug when removing the power plug from the outlet. Do not bend the cord excessively or put a heavy object on it. This may cause fire, overheating, electric shock or damage.

## General Precautions

---



- If something appears to be wrong with the AC Adapter, unplug the AC Adapter from the outlet and consult your nearest service center. Using the AC Adapter may cause fire, overheating, electric shock or injury.



- Do not use or keep the AC Adapter in very hot places, such as in direct sunlight, in a closed car on a sunny day, near a heater, on an electric carpet, etc. Do not use the AC Adapter if something is covering it (such as a blanket). This may cause fire, explosion, leakage or overheating.

# 1 Getting Started

## Main Features

---

- Slide switch operation for ease of use and fast response.
- Supports two types of memory: SD card and microSD card (☞ P.12).
- Three Programmable smart buttons F1,F2 and F3 (☞ P.68).
- Recording and storing voice in Digital Speech Standard Pro (DS2 format).
- Two recording modes, QP (Quality Playback) mode or SP (Standard Playback) mode (☞ P.32).
- Data encryption function for securing recordings on the device.
- The recorder's Ni-MH Rechargeable Battery Pack can be charged in the recorder using the USB cable or the AC adapter (☞ P.18, 19).
- Supports USB 2.0. High-Speed, which enables high-speed data transmission from the recorder to your computer.
- Five folders and up to 200 files/folder, for a maximum of 1000 recordings (☞ P.27).  
When using DSS Player, it is possible to create up to a maximum of seven folders (1,400 files) (☞ P.68, 69).
- Large LCD screen with backlight.
- Device Lock function to prevent unauthorized access to device (☞ P.68).  
Authentication system via password or fingerprint scan\* (☞ P.46-49).
- Indexmark function which is useful to search particular points in the dictation (☞ P.57).
- Verbal comment function which allows transcriptionists to instantly search and play back instructions on their computer (☞ P.56).
- Priority Setting (☞ P.52).
- DSS Player software included (☞ P.69).  
It is possible to customize the recorder in a number of ways.

\*DS-5000iD only

# Memory Card

This recorder uses dual memory in the form of SD card memory and built-in memory (microSD card), allowing you to record to the selected memory. A removable microSD card is used for the built-in memory thus allowing you to remove your recording from the recorder safely in case of recorder malfunction or failure.

## Compatible Cards

The recorder supports cards with memory capacity between 512 MB to 8 GB.

### Settings and operating environment relating to the card

Check the latest operating information on the Olympus homepage (<http://www.olympus.com>) when using cards other than the included card. In addition, refer to the following pages as well when handling the card.

- Inserting and Ejecting a SD card (P.23)
- Inserting and Ejecting a microSD card (P.63)
- Setting Recording Destination (Card Select) (P.26)
- Formatting the Card (Format) (P.64)

### SD card

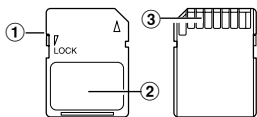

### microSD card

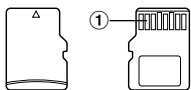

### SD card

- 1 Card Lock**  
SD card is equipped with a lock function. When the lock function is used, important data is protected by preventing it from being accidentally overwritten or erased. When the lock function is set  will appear on the display.
- 2 Index area**  
For writing down information identifying card or content.
- 3 Contact area**  
Comes into contact with the recorder's signal read contacts.

### microSD card

- 1 Contact area**  
Comes into contact with the recorder's signal read contacts.

## Memory Sizes of Cards and Approximate Recording Times\*1

| Memory Size | QP Mode           | SP Mode            |
|-------------|-------------------|--------------------|
| 512MB       | 38 hr. 45 min.    | 79 hr. 30 min.     |
| 1GB         | 77 hr. 40 min.    | 159 hr. 05 min.*2  |
| 2GB         | 157 hr. 55 min.*2 | 323 hr. 35 min.*2  |
| 4GB         | 310 hr. 10 min.*2 | 635 hr. 25 min.*2  |
| 8GB         | 631 hr. 15 min.*2 | 1293 hr. 15 min.*2 |

The above are the standard times, and the available recording time will vary depending on the card.

- \*1: Available recording time for one continuous file.  
Available recording time may be shorter if many short recordings are made.
- \*2: Total recording time of several files. The maximum recording time per file is 99 hours 59 minutes.

## ⚠ Warning



- Do not touch the card contacts. That may damage the card.



- Do not place the card in locations with static electricity.



- Store the card in a location that is out of the reach of children. In case of accidental ingestion, consult a physician immediately.

## Check Card Information (Card Info.)

Information such as the memory capacity and remaining memory for installed cards can be displayed on the recorder (☞ P.42).

| Card Info. |        |
|------------|--------|
| ■ SD       |        |
| Remain     | 540MB  |
| Capacity   | 1024MB |
| ■ micro SD |        |
| Remain     | 250MB  |
| Capacity   | 512MB  |
| BACK       | EXIT   |

## Notes

- When initializing (formatting) a card, confirm that no necessary data is stored on the memory card beforehand. Initialization completely erases the existing data on the card.
- In some cases cards which have been formatted (initialized) by another device, such as a computer, cannot be recognized. Be sure to format them with this recorder before using.
- The card has a service life. When reaching the end of its life, writing or erasing data on the card will be disabled. In this case, replace the card.
- If you use a PC card adapter compatible with the card to save or delete some data on the card, the maximum recording time on the card may be decreased. To recover the original recording time, initialize/format the card in the recorder.
- Olympus will not be held liable for any data corruption or loss due to misuse of the media card.

# Identification of Parts

1

Identification of Parts

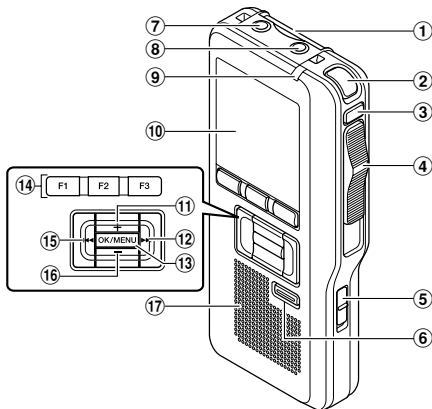

- ① SD card slot
- ② Built-in microphone
- ③ NEW button
- ④ Slide (REC/STOP/PLAY/REV) switch
- ⑤ POWER (ON/OFF) switch
- ⑥ ERASE button
- ⑦ EAR (Earphone) jack
- ⑧ MIC (Microphone) jack
- ⑨ Record/Play indicator light
- ⑩ Display (LCD panel)
- ⑪ + (Volume) button
- ⑫ Fast Forward (▶▶) button
- ⑬ OK/MENU button

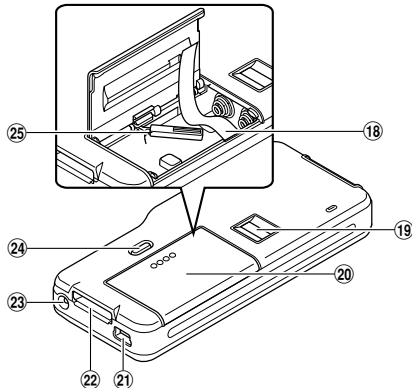

- ⑭ Programmable smart button (F1,F2,F3)
- ⑮ Rewind (◀◀) button
- ⑯ – (Volume) button
- ⑰ Built-in speaker
- ⑱ Battery removal tape
- ⑲ Fingerprint sensor\*
- ⑳ Battery cover
- ㉑ PC (USB) terminal
- ㉒ Cradle connector
- ㉓ Power jack
- ㉔ Battery cover release button
- ㉕ microSD card cover

\*DS-5000ID only

## Display Status Indicators

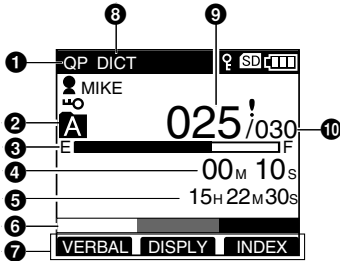

Display in the recording mode

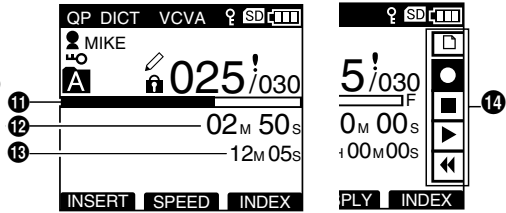

Display in the playback mode

- ❶ Record mode indicator
- ❷ Current folder
- ❸ Memory remaining indicator (E/F bar)
- ❹ Recording elapsed time
- ❺ Remaining recording time
- ❻ Level meter indicator
- ❼ Button guide display
- ❽ Microphone sensitivity indicator

- ❾ Current file number
- ❿ Total number of files in the folder
- ⓫ Playback position bar indicator
- ⓬ Current Playback time
- ⓭ Total recording time of the selected file
- ⓮ Slide Switch Guide

You can display the slide switch guide by using "Slide Switch Guide settings" (P.68) of the customize functions of DSS Player.

- 👤 Author ID indicator
- 🔋 Battery indicator
- 📁 SD SD card indicator
- 📁 microSD microSD card indicator
- 🗣️ VCVA (Variable Control Voice Actuator) indicator

- 🔪 Pending indicator
- 🔒 Card Lock indicator
- 🔒 Encryption indicator
- ⚡ Priority indicator
- 🔒 Erase Lock indicator

# Installing Batteries

This recorder can be used with either Ni-MH Rechargeable Battery Pack or AAA Alkaline Batteries.

## Ni-MH Rechargeable Battery Pack (included)

- 1 Lightly press down on the battery cover release button, then open the battery cover, as shown in the illustration below.

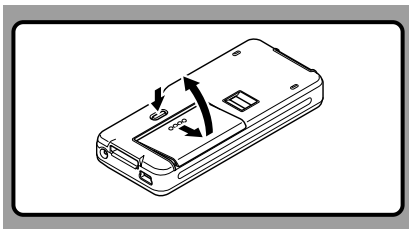

- 2 Insert the Ni-MH Rechargeable Battery Pack, observing the correct polarity as shown in the illustration below, then close the battery cover.

When using the Ni-MH Rechargeable Battery Pack, insert it so that the flat surface with the polarities is facing down as shown in the illustration below. **Exercise caution, as the directions inscribed inside the battery compartment apply to AAA batteries only.**

In addition, when inserting the battery pack, insert them so that the tape is under the battery pack, as shown in the illustration. The battery pack can then be removed easily by pulling up the tape.

When pulling on the tape the battery pack may suddenly pop out, so be sure to press down lightly the battery pack with your finger while pulling.

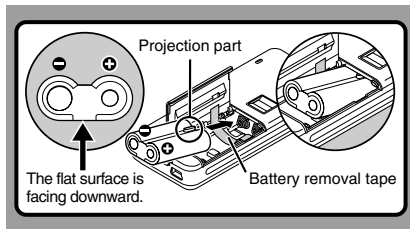

The battery pack needs to be fully charged in the recorder before initial use.

## Recharging Battery Pack

The battery indicator on the display changes as the battery pack lose power.



When [ ] appears on the display, charge the battery pack as soon as possible.

When the battery pack charge is low, the recorder shuts down and [ ] Battery Low] appears on the display.

## Notes

- Removing the battery pack while the recorder is in use may corrupt the file.
- If power runs out during recording, current file will be lost or corrupted!
- It is crucial to charge the battery pack once you see one hash mark on the display battery indicator.
- Remove the battery pack if you are not going to use the recorder for an extended period of time.



### AAA Alkaline Batteries

- 1 Lightly press down on the battery cover release button, then open the battery cover.
- 2 Insert two AAA batteries, observing the correct polarity as shown in the illustration below, then close the battery cover.

Insert the batteries in the direction inscribed on the inside of the recorder's battery compartment. In addition, when inserting the batteries, insert them so that the tape is under the batteries, as shown in the illustration. The batteries can then be removed easily by pulling up the tape. **When pulling on the tape the batteries may suddenly pop out, so be sure to press down lightly the batteries with your finger while pulling.**

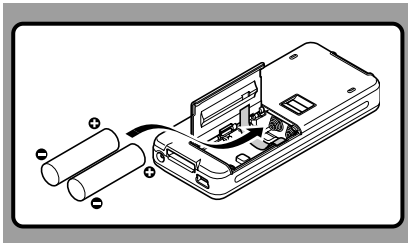

The battery indicator on the display changes as the batteries lose power.

### Replacing Batteries

When  appears on the display, replace the batteries as soon as possible.

When the batteries are too weak, the recorder shuts down and  Battery Low] appears on the display.

### Cautions Concerning the Battery

#### ⚠ Warning



- Using batteries for which part or all of the external coating (insulating sheath) is peeling off or batteries which have ruptured may cause fluid leaks, overheating, and explosions. For this reason such batteries should absolutely not be used.
- Commercially available batteries for which part or all of the external coating (insulation sheath) has been peeled off should absolutely not be used.

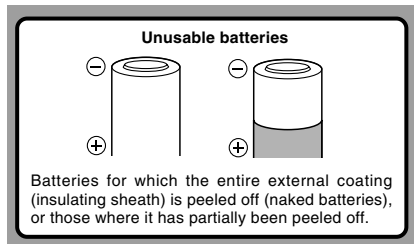

### Notes

- **Be sure to turn OFF the recorder before replacing the batteries.** Removing the batteries while the recorder is in use may corrupt the card. If you are recording into a file and the batteries run out, you will lose your currently recorded file since the file header will not be written. It is crucial to replace the batteries when one hash mark is shown in the battery icon.
- Be sure to replace both batteries at the same time.
- **Never mix old and new batteries, or batteries of different types and/or brands.**
- If it takes longer than 1 minute to replace dead batteries, you may have to reset the time when you load new batteries.
- Remove the batteries if you are not going to use the recorder for an extended period of time.

# Charging Battery Pack

You can charge the Ni-MH Rechargeable Battery Pack in the recorder using the cradle in combination with the USB cable or AC Adapter. Or by directly connecting the AC Adapter or USB cable to the recorder.

Battery pack need to be fully charged before first use.

Full charge time: Approximately 3 hours.

## Charge the Ni-MH Rechargeable Battery Pack using the Cradle

The Ni-MH Rechargeable Battery Pack in the recorder can be charged by connecting the AC adapter or USB cable to the cradle with the recorder set in it.

### Charging using Cradle and AC Adapter

**Connect the AC adapter to the cradle.**

For connection procedures, see P.75. When using the AC adapter for charging, connect the power plug to the cradle AC connector (☞ P.21).

**Firmly press the recorder all the way into the cradle as shown in the illustration.**

CHARGE indicator light glows red and the charging starts.

The light goes out when the charging is complete.

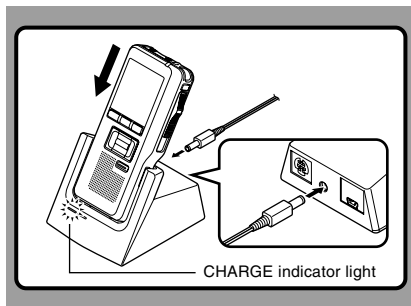

### Charging using Cradle and USB Cable

**Connect the USB cable to the cradle.**

For connection procedures, see P.75.

**Turn the recorder's POWER switch OFF (☞ P.22), then firmly press the recorder all the way into the cradle as shown in the illustration.**

CHARGE indicator light glows red and the charging starts.

The light goes out when the charging is complete.

When the recorder is connected to a USB cable while its POWER switch is turned OFF, only charging will be performed, and the computer will not recognize it as a drive.

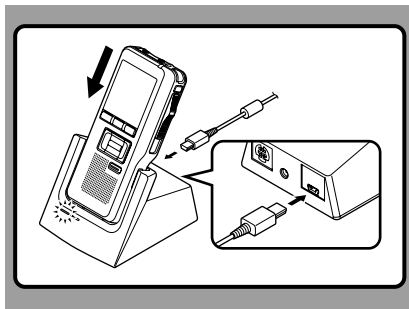

## Directly Charging Through the Recorder

The Ni-MH Rechargeable Battery Pack in the recorder can be charged by connecting an AC adapter or USB cable to the recorder.

### Charging using AC Adapter (no cradle)

#### Connect the AC adapter to the recorder.

For connection procedures, see P.21. When using the adapter for charging, connect the power plug to the recorder power jack.

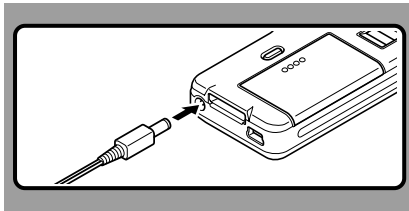

### Charging using the USB cable (no cradle)

#### While recorder's POWER switch is turned OFF, connect the USB cable to the recorder.

When the recorder is connected to a USB cable while its POWER switch is turned OFF, only charging will be performed, and the computer will not recognize it as a drive.

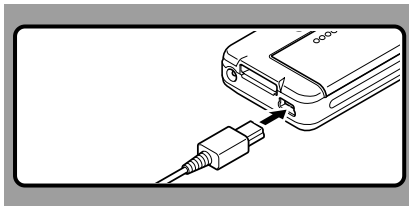

### Notes

- Charge the battery pack often for first few uses. Battery pack performs better after several full charge/discharge cycles.
- Battery packs other than the supplied battery pack cannot be charged.
- If you charge the battery pack right after charging is complete, it will take only few minutes to charge the battery pack.
- The PC must be ON when charging battery pack via the USB cable connection.
- Charging battery pack via the USB cable connection may not be successful depending on the power supply capacity of your PC. Use the AC adapter instead.
- Do not set or remove the recorder from the cradle while it is in operation.
- Do not charge the recorder with the USB hub connected.
- Do not attach or remove the rechargeable battery pack if the AC adapter or USB cable is connected.

# Using the Battery Pack

1

Using the Battery Pack

The battery pack is exclusively for use with Olympus voice recorder DS-5000/DS-5000iD. Never use them in combination with other equipment.

## Discharging

Battery pack self-discharge while this is not in use. Be sure to charge them regularly before use.

## Battery life

Over time, rechargeable battery packs gradually wear down. If you charge you battery pack regularly and you notice a decrease in usage time, then it is probably time to purchase a new battery pack.

## Operating temperature

Rechargeable batteries, such as the battery pack, are chemical products. Batteries efficiency may fluctuate even when operating within the recommended temperature range. This is an inherent nature of such products.

## Recommended temperature range for use

### Discharging (when using appliance):

0°C - 42°C/32°F - 107.6°F

### Charging:

5°C - 40°C/41°F - 104°F

### Storage:

-20°C - 30°C/-4°F - 86°F

Using the battery pack outside the above temperature range may result in declining efficiency and shorter battery life.

In order to prevent battery leakage or rust, remove the battery pack from the products when you will not be using them for a long time, and store them separately.

## Notes

- This recorder is designed to fully charge battery pack regardless of their energy level. However, for best results when charging newly purchased battery pack or battery pack that have not been used for a long time (more than one month), it is recommended to fully charge the battery pack then discharge repeatedly for 2 to 3 times.
- When disposing battery packs, always observe the local laws and regulations. Contact you local recycling center for proper disposal methods.
- If Ni-MH rechargeable battery pack is not fully discharged, protect against short-circuiting (e.g. by taping the contacts) before disposing.

**(NL) Batterij niet weggooien, maar inleveren als KCA.**



## For customers in Germany

Olympus has a contract with the GRS (Joint Battery Disposal Association) in Germany to ensure environmentally friendly disposal.

# Using the AC Adapter

Use the AC adapter (included) in cases where battery consumption is a concern, such as when recording for extended periods of time.

Plug the AC adapter (included) into a household power outlet and connect the power plug to the recorder's power connector (DC 5V). Always turn off the recorder before you connect power.

Refer to P.18-19 regarding supplying power to the recorder and cradle with the aim of charging the Ni-MH Rechargeable Battery Pack (refer P.16).

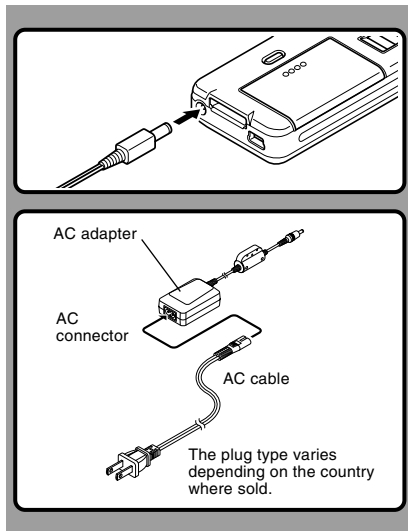

## ⚠ Warning



- Always stop recording before connecting or disconnecting power.



- When the AC adapter is not in use, disconnect the power supply plug from the power outlet.



- Use only the correct power supply voltage as indicated on the adapter.

## Detecting abnormal voltage

If the recorder detects a DC power voltage outside of the allowable voltage (allowable voltage: 4.6 to 5.5 V), then [Power Supply Error Remove Power Plug] will appear on the display and all operations will stop. The recorder will not be operable while abnormal voltage is detected. Use the included AC adapter.

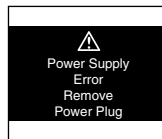

# Turning ON the Recorder

With the battery charged in the recorder and the card inserted properly, the recorder is ready to work.

While the POWER switch on the side of the recorder is in the OFF position, none of the buttons or switch on the recorder will be active. Move the POWER switch to the ON position to activate the recorder.

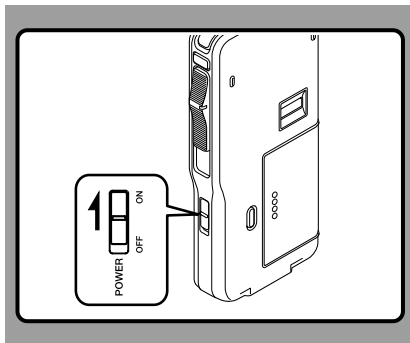

# Power Save Mode (Power Save)

When the recorder is ON but not in use for 10 minutes, by default, it will switch to power save mode automatically. To reactivate the recorder again, operate any button or the slide switch.

## Power Save Setting

You can set the time to enter Power Save mode from among [5 min.], [10 min.], [30 min.], [1 hour], and [Off] .

To exit power save, press any button.

The [Power Save] setting can be changed from the Menu. For more details, refer to “Menu List” (☞ P.41) and “Learning to Use the Menu” (☞ P.43).

| Power Save |      |
|------------|------|
| 5min.      |      |
| 10min.     |      |
| 30min.     |      |
| 1 hour     |      |
| Off        |      |
| BACK       | EXIT |

# Inserting and Ejecting a SD card

## Inserting a SD card

Insert the SD card into the card slot in the direction shown in the illustration until it clicks.

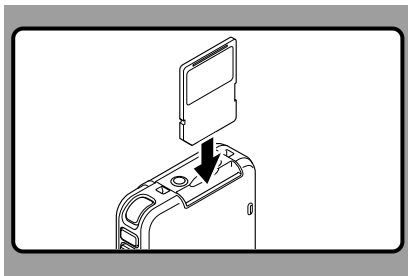

This recorder uses a microSD card as its built-in memory. The microSD card has been preloaded. Refer to P.63 when removing or inserting the card during emergencies.

## Ejecting a SD card

Push the SD card inward once to unlock it, and let it eject.

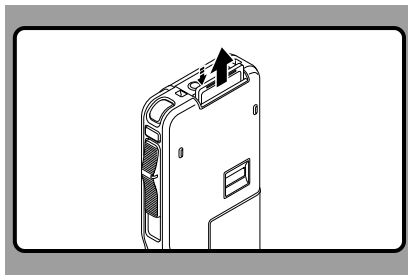

## Recorder Card Selection

When inserting SD card into the SD card slot, the recorder message [Please Wait] will flash on the LCD display for few seconds while validating the SD card.

The recorder recording destination will be the default location selected from the menu [Card Select] option when available. In case the default location is not available, the recorder will automatically change over to the other card. When SD card selected from the menu [Card Select] option is ejected from the recorder, the recorder will automatically change over the recording destination to the other card.

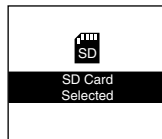

## Notes

- Insert the card keeping it straight.
- The card stops with a click when it is inserted all the way.
- Inserting the card the wrong way or at an angle could damage the contact area or cause the card to jam.
- If the card is not inserted all the way, data may not be written to the card.
- Hold the card straight and pull it out.
- If a unformatted card is installed, the recorder will automatically display the menu format option (☞ P.64).
- Never use any card in the recorder unless it has been formatted on this unit (☞ P.64).
- Never remove the card while the recorder is in operation. This may damage the data.
- Releasing your finger quickly after pushing the card inward may cause it to eject forcefully out of the slot.

# Setting Time and Date (Time & Date)

1

Setting Time and Date

Setting the correct time and date on the recorder is very important since every file recorded on the recorder will have the time and date information as part of the file header. This will simplify the file management aspects later on.

The hour indicator will flash automatically when you load batteries before using the recorder for the first time, or after the recorder hasn't been used for a long time. However, when a Password or Fingerprint (DS-5000iD only) has been set as the device lock function (see P.46), the recorder will go to the time and date set screen after verification (unlocking).

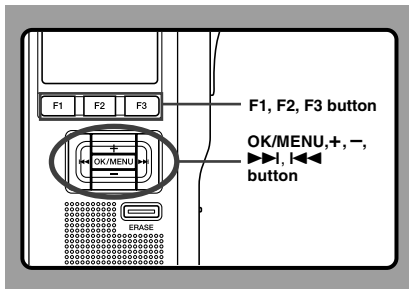

## 1 Press the >>> or <<< button to select the item to set.

Select the item from "hour", "minute", "year", "month" and "day" with a flashing point.

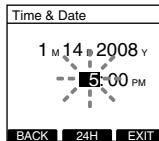

## 2 Press the + or - button to set.

Follow the same steps by pressing the >>> or <<< button to select the next item, and press the + or - button to set.

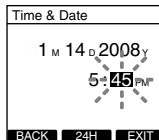

- You can choose between 12 and 24 hour display by pressing the F2(24H or 12H)\* button while setting the hour and minute.

Example: 5:45 P.M.

5:45 PM (Initial setting) ↔ 17:45



- You can choose the order of the year, month, day by pressing the F2(D/M/Y or Y/M/D or M/D/Y)\* button while setting them.

Example: January 14, 2008

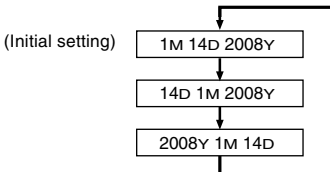

\*The display will vary depending on the status of the settings.

### 3 Press the **OK/MENU** button to complete the setup screen.

The clock will start from the set date and time. Press the OK/MENU button according to the time signal.

## Notes

- If the slide switch is moved to a position other than STOP while setting the time and date, the time and date currently being set (un-finalized time and date) will be cancelled and it will revert to the previously set time and date.
- You can set the time and date from your PC using DSS Player software (☞ P.69).

## Changing the Time and Date

When the recorder's POWER switch is turned ON the [Time & Date] will be displayed for two seconds. If the time and date is not correct, set it using the procedure below.

- 1 Press the **+** or **-** button in the [Device Menu] screen, then select [Time & Date]. See P.42 regarding the menu.

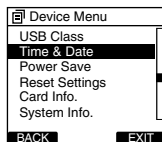

- 2 Press the **OK/MENU** or **▶▶▶** button. The time and date screen appears. The hour indicator flashes, indicating the start of the time and date setup process. The following steps are the same as Step 1 through Step 3 of "Setting Time and Date (Time & Date)" (☞ P.24).
- 3 Press the **F1(BACK)** or **◀◀◀** button to return to the [Main Menu] screen, then press the **F3(EXIT)** or **◀◀◀** button to complete the setting.

# Setting Recording Destination (Card Select)

By default, the recording destination is set to the [SD] at the factory. To change the recording destination, follow the procedure outlined below.

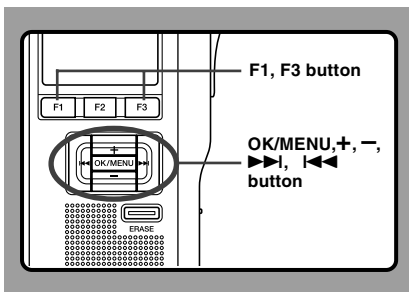

- 1 Select [Card Select] at the [Device Menu] screen, then press the **OK/MENU** or **>>>** button.

Refer to P.42 regarding each menu item settings.

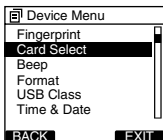

- 2 Press the **+** or **-** button to select [SD] or [micro SD].

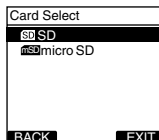

- 3 Press the **OK/MENU** button to complete the setup screen. [SD Card Selected] or [microSD Card Selected] will light up on the display, and it will return to the [Device Menu] screen.

If press the **<<<** or **F1(BACK)** button the setting will be cancelled and it will return to the [Device Menu] screen.

The recording destination (**SD** or **mSD**) that was set will appear on the display.

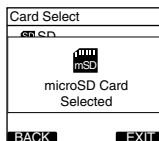

- 4 Press the **F1(BACK)** or **<<<** button to return to the [Main Menu] screen, then press the **F3(EXIT)** or **<<<** button to complete the setting.

# 2 Basic Operations

## Recording

By default, the recorder has five folders, A, B, C, D, E and you can select folder by pressing the F1(FOLDER) button. These five folders can be selectively used to distinguish the kind of recording; for example, Folder A might be used to store private information, while Folder B might be dedicated to holding business information. Up to 200 messages can be recorded per folder.

Also, by default, the Recording Mode is QP.

### Record Function

By default, the RECORD function is configured to record at the current position (overwrite). However, that can be changed to any of the following settings:

- Append: Appends the recording to the end of the current file (☞ P.28).
- Overwrite: Overwrites the recording starting at the current position in the file (☞ P.29).
- Insert: Inserts the recording at the current position in the file (☞ P.30).

### Recording Related Settings

Recording related settings can be configured to provide a suitable recording environment.

- Microphone Sensitivity (Mic Sense) (☞ P.31)
- Recording Modes (Rec Mode) (☞ P.32)
- Using the Variable Control Voice Actuator (VCVA) (☞ P.33)
- Hands-free Recording (☞ P.34)
- Recording Monitor (☞ P.34)
- Verbal Comment (☞ P.56)
- Pending Files (Pending) (☞ P.51)

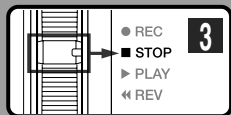
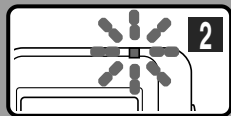
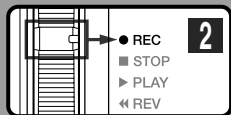
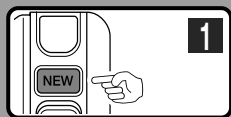

## New Recording

Create a new file to record in.

### 1 Press the **NEW** button to create a new file.

When [The Worktype List is displayed when a new file is created.] is set in DSS Player (P.69) you can select the Work Type from the Work Type list.

- (a) Selected Author ID
- (b) New file number
- (c) Remaining recording time



### 2 Move the slide switch to the **REC** position to start recording.

The record/play indicator light glows red. Aim the microphone at the sound source. When you press the F2 (DISPLY) button during recording, you can change the LCD screen displays.

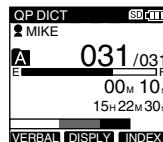

### 3 Move the slide switch to the **STOP** position to stop recording.

If you want to append additional recordings to the same file, move the slide switch to the REC position again.

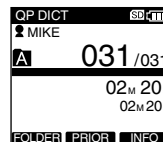

## Notes

- A beep will sound when the remaining recording time reaches 60 seconds, 30 seconds, and 10 seconds while recording.
- When remaining recording time is less than 60 seconds, the record/play indicator light starts flashing in red. When the recording time is decreasing to 30 or 10 seconds, the light flashes faster.
- [Memory Full] or [Folder Full] will be displayed when the memory or folder capacity is full.
  - Delete any unnecessary files before recording any further (P.37) or transfer dictation files to your computer using DSS Player Software (P.69).
  - Change the recording destination at [Card select] setting (P.26) or change to a card with free space.

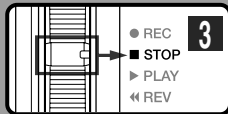
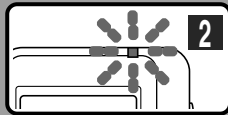
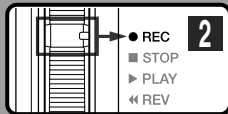
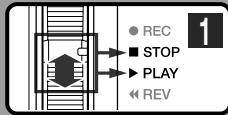

## Overwrite Recording

You can overwrite a previously recorded file from any point within the file.

Note that the overwritten recordings will be erased.

### 1 Select and play the file you want to overwrite.

Stop playback at the starting point of overwrite.

### 2 Move the slide switch to the REC position to start overwriting.

The record/play indicator light glows red.

- Ⓐ Recording elapsed time
- Ⓑ Total recording time of the selected file

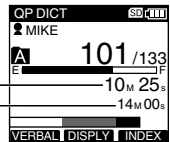

### 3 Move the slide switch to the STOP position to stop overwriting.

#### Note

- You cannot select a different recording mode (QP, SP) than that of the original file before overwrite recording.

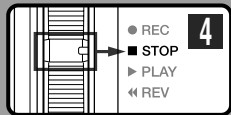
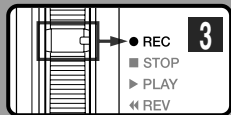
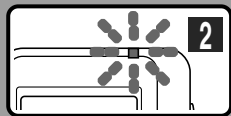
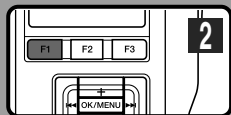
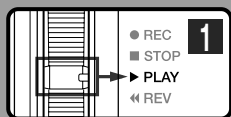

## Insert Recording

Additional recording can be inserted into previously recorded file.

**1** Select and play the file you want to insert an additional recording into.

**2** While playing the file, press the **F1 (INSERT)** button to insert an additional recording.

[Insert Rec?] appears on the display.

**3** Move the slide switch to the **REC** position to start inserting an additional recording.

The record/play indicator light glows red. [Insert Rec] and the remaining recording time will alternate on the display.

**4** Move the slide switch to the **STOP** position to stop inserting the additional recording.

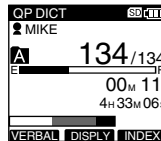

### Notes

- If you place the slide switch in the STOP position for more than two seconds while moving the slide switch from the PLAY position to the REC position, the Insert recording will be cancelled.
- The recording time and date of the file is updated to the time and date of the inserted recording.
- You cannot select a different recording mode (QP, SP) than that of the original file before inserting.

# Microphone Sensitivity (Mic Sense)

You can switch between two microphone sensitivities to meet recording needs: [Dictation] for oral dictation and [Conference] which is suited for situations like meetings and conferences with a small number of people. The setting status will appear on the display as **CONF** or **DICT**.

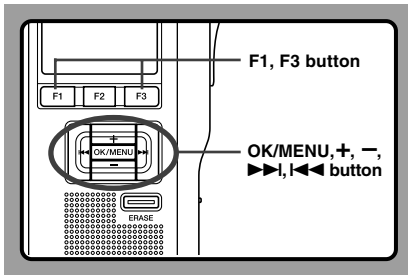

- 1 Select [Mic Sense] at the [Record Menu] screen, then press the **OK/MENU** or **>>>** button.  
Refer to P.41 regarding each menu item settings.

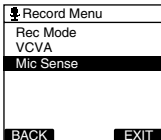

- 2 Press the **+** or **-** button to select [Conference] or [Dictation].  
**Conference**...High-sensitivity mode that records sounds in all directions.  
**Dictation**...Low-sensitivity mode suited for dictation.

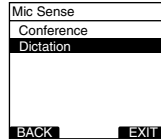

- 3 Press the **OK/MENU** button to complete the setup screen.  
[Conference Set] or [Dictation Set] will light up on the display, and it will return to the [Record Menu] screen.  
If press the **<<<** or F1(BACK) button the setting will be cancelled and it will return to the [Record Menu].  
Pressing the F3(EXIT) button will cancel the contents being set and take you out of the MENU.

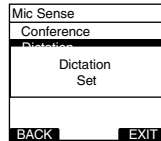

- 4 Press the **F1(BACK)** or **<<<** button to return to the [Main Menu] screen, then press the **F3(EXIT)** or **<<<** button to complete the setting.



# Recording Modes (Rec Mode)

The recording mode can choose between QP (Quality Playback) and SP (Standard Playback).

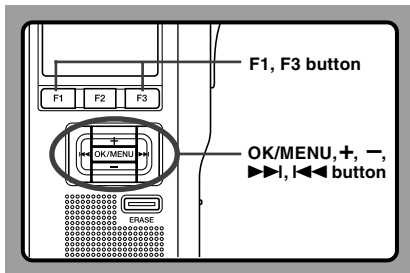

- 1 Select [Rec Mode] at the [Record Menu] screen, then press the **OK/MENU** or **>>>** button.

Refer to P.41 regarding each menu item settings.

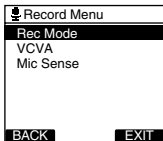

- 2 Press the **+** or **-** button to select [QP] or [SP].

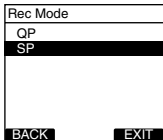

- 3 Press the **OK/MENU** button to complete the setup screen.

[QP Set] or [SP Set] will light up on the display, and it will return to the [Record Menu] screen.

If press the **<<<** or **F1(BACK)** button the setting will be cancelled and it will return to the [Record Menu]. Pressing the **F3(EXIT)** button will cancel the contents being set and take you out of the MENU.

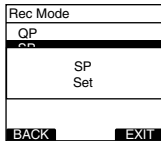

- 4 Press the **F1(BACK)** or **<<<** button to return to the [Main Menu] screen, then press the **F3(EXIT)** or **<<<** button to complete the setting.

Set Recording Mode is displayed when creating the NEW File and during recording.

The recording mode of file recording is displayed when during playback and in stop mode.



## Note

- You cannot select the QP mode when setting the recorder to the Classic DSS mode. For details, see "Dictations Settings" in the "Customizing the Recorder" (⇨ P.68).



# Using the Variable Control Voice Actuator (VCVA)

The Variable Control Voice Actuator (VCVA) is a function that starts recording automatically when the microphone senses that sounds have reached a preset threshold volume level, and automatically pauses when the volume drops below the threshold. The VCVA feature allows you to conserve memory by automatically stopping recording in instances like long silent periods during meetings. When this is enabled, **VCVA** will appear on the display.

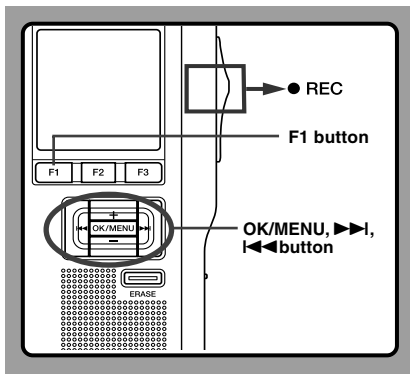

- 1 **Set the VCVA in the menu to [On].**  
Refer to P.41 regarding each menu item settings.

- 2 **Move the slide switch to the REC position to start recording.**

When the sound volume is lower than the preset actuation sound level, recording automatically stops after 1 second approximately, and "Stand by" flashes on the display. The record/play indicator light glows when recording starts and flashes when recording pauses.



## Adjust the Start/Stop Actuation Level

**While the recorder is recording mode, press the ►► or ◀◀ button to adjust the actuation level.**

The VCVA level can be set to any of 15 different values. The higher the value is, the more sensitive the recorder can react to sounds. At the highest value, even the faintest sound will activate recording.

The VCVA actuation level can be adjusted according to the ambient (background) noise.

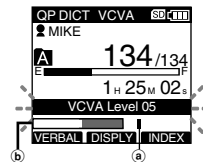

- Start level**  
(Varies according to the sound volume being recorded)
- Level meter indicator** (moves to the left/right according to the set level)

## Notes

- The start/stop actuation level also varies depending on the selected microphone sensitivity mode (see P.31).
- To ensure successful recordings, prior testing and adjustment of the start/stop actuation level is recommended.

# Hands-free Recording

The recorder can be used as a hands-free recording device. To setup the recorder for hands-free operation, connect the optional Olympus foot switch (RS27/28) to the back of the cradle and place the recorder in the cradle as shown in the diagram below. You can set Hands-free operation of the recorder to [Dictation] (default) or [Transcription] by using the customize functions of DSS Player (P.68) and change the allocation function to Foot Pedal.

For more details, refer to the online help for DSS Player (P.73).

**The default settings of the foot switch functions are as follow (Dictation) :**

| RS27   |                |         |
|--------|----------------|---------|
|        | Press and hold | Release |
| Left   | NEW            | -       |
| Center | REC            | STOP    |
| Right  | REV            | PLAY    |

| RS28   |                |         |
|--------|----------------|---------|
|        | Press and hold | Release |
| Left   | REW            | PLAY    |
| Center | NEW            | -       |
| Right  | REC            | STOP    |

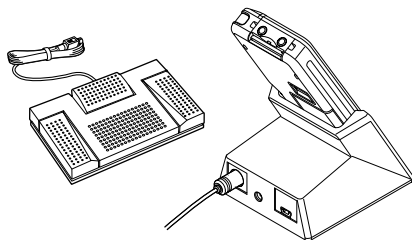

## Notes

- The Olympus foot switch (RS27/28) is sold separately.
- Move the slide switch of the recorder to the STOP position before connecting it to the cradle for hands-free recording.
- To record with better quality using the hands-free recording function, set the microphone sensitivity to [Conference] mode, or use an external microphone.

## Recording Monitor

It is possible to monitor your recording by listening to the recording while recording is in progress. Insert the earphone plug into the earphone jack and use the + or - button to control the volume level.

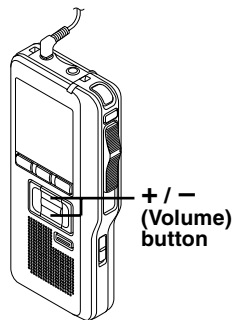

## Note

- Insert the plugs to the end as shown in the illustration when inserting the earphone or external microphone.

# Playing

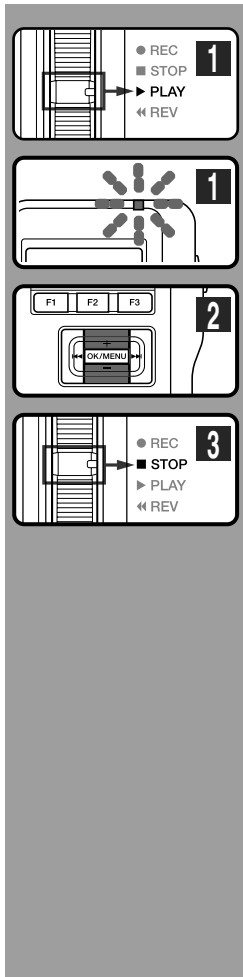

You can start playing a file at any point.

- 1 **Select the file, then move the slide switch to the **PLAY** position to start playback.**

The record/play indicator light glows green.

- 2 **Press the **+** or **-** button to adjust the volume.**

The display shows the volume level. You can choose between 0 to 30.

Ⓐ **Volume level**

- 3 **Move the slide switch to the **STOP** position at any point you want to stop the playback.**

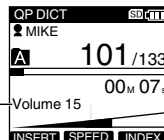

2

Playing

| Playback functions       | Operation                                                                                                                                                                                                                                                                                                                                                                                                     | How to Cancel                                                                                                                        |
|--------------------------|---------------------------------------------------------------------------------------------------------------------------------------------------------------------------------------------------------------------------------------------------------------------------------------------------------------------------------------------------------------------------------------------------------------|--------------------------------------------------------------------------------------------------------------------------------------|
| <b>Fast Forward (FF)</b> | Press the ►► button once while stopped.                                                                                                                                                                                                                                                                                                                                                                       | Move the slide switch to a position other than the <b>STOP</b> position.<br>➡ The recorder starts the operation of the set position. |
| <b>Rewind (REW)</b>      | Press the ◀◀ button once while stopped.                                                                                                                                                                                                                                                                                                                                                                       |                                                                                                                                      |
| <b>Cue (CUE)</b>         | Press and Hold the ►► button while stopped or playing a file.                                                                                                                                                                                                                                                                                                                                                 | Release the button.                                                                                                                  |
| <b>Review (REV)</b>      | Press and Hold the ◀◀ button while stopped or playing a file.<br>Move the slide switch to the <b>REV</b> position.                                                                                                                                                                                                                                                                                            | Release the button.<br>Release the slide switch.                                                                                     |
| <b>Playback Speed</b>    | Press the <b>F2 (SPEED)</b> button during playback.<br>➡ Every time the <b>F2(SPEED)</b> button is pressed, the playback speed will switch.<br><b>Play(playback):</b> Playback at normal speed.<br><b>Slow Play (slow playback):</b> Playback speed slows down (-50%), and "Slow play" will turn on.<br><b>Fast Play (fast playback):</b> Playback speed becomes faster (+50%), and "Fast play" will turn on. |                                                                                                                                      |

### Notes

- If you press the ►► button once while fast-forwarding or twice while stopped, the recorder will stop at the end of the file (F.Skip).
- If you press the ◀◀ button once while rewinding or twice while stopped, the recorder will stop at the beginning of the file (B.Skip). If the ◀◀ button is pressed within 2 seconds, the recorder skips to the beginning of the previous file.
- If you continue to press and hold the ►► button while Fast Forwarding (FF) the recorder will F.Skip continuously while the button is held.
- If you continue to press and hold the ◀◀ button while Rewinding (REW) the recorder will B.Skip continuously while the button is held down.

# Erasing

## Erasing a File

Erasing or deleting a file from any of the folder on the recorder is a very simple process.

- 1 Select the file you want to erase.
- 2 Press the **ERASE** button.
- 3 Press the **+** button to select [File Erase], then press the **OK/MENU** button.
- 4 Press the **+** button to select [Start], then press the **OK/MENU** button.  
The display changes to [File Erase !] and erasing will start.

[Erase Done] is displayed when the file is erased. File numbers will be reassigned automatically.

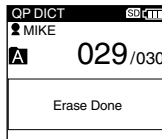
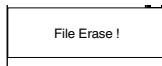
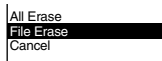

2

Erasing

### Notes

- An erased file cannot be restored.
- Files cannot be erased in the following cases.
  - File being set [Lock] (☞ P.50).
  - The SD card lock is turned on while the SD card is selected as the recording destination (☞ P.12).

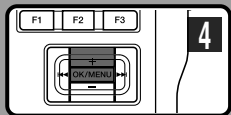
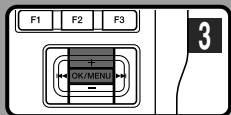
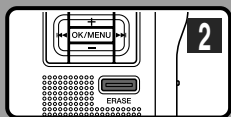

## Erasing All Files in a Folder

All files in a folder can be erased simultaneously.

- 1 Select the folder you want to erase.
- 2 Press the **ERASE** button.
- 3 Press the **+** button to select **[All Erase]**, then press the **OK/MENU** button.
- 4 Press the **+** button to select **[Start]**, then press the **OK/MENU** button. The display changes to [All Erase !] and erasing will start.

[Erase Done] is displayed when the files are erased. Any locked files in the folder will be reassigned new file numbers in ascending order.

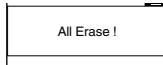
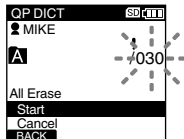
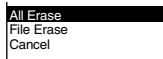

### Notes

- The erasing process may take up to 10 seconds. Do not interrupt this process! Data will be destroyed.
- Files cannot be erased in the following cases.
  - File being set [Lock] (☞ P.50).
  - The SD card lock is turned on while the SD card is selected as the recording destination (☞ P.12).

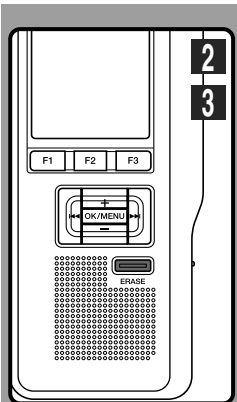

## Partially Erasing a File

You can erase a selected file in part.

**1 Start playback the file you want to erase partially.**

**2 Press the ERASE button at the point to start erasing.**

While playback continues, [Partial Erase] will appear on the display.

**3 Press the ERASE button at the point to end erasing.**

The erase starting point (time) set in step 2 and the ending point (time) set in this step will alternate on the display for 8 seconds.

If you playback to the end of file or to the start position of the Verbal comment (see P.56), that will mark the end position for the partial erase automatically.

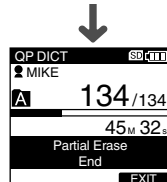

2

Erasing

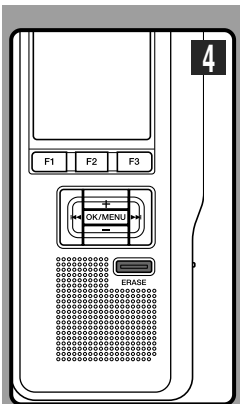

#### 4 Press the **ERASE** button to confirm erase.

The display changes to [Partial Erase!] and erasing will start.

When [Erase Done] appears on the display, partial erase is complete.

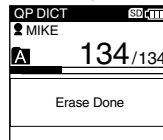
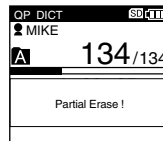

#### Notes



- If the ERASE button is not pressed within 8 seconds after the “Partial Erase Start” and “Partial Erase End” are alternately displayed, the recorder will revert to stop status.
- An erased file cannot be restored.
- Files cannot be Partial erased in the following cases.
  - File being set [Lock] (☞ P.50).
  - Files that Verbal comment is being played back (☞ P.56).
  - The SD card lock is turned on while the SD card is selected as the recording destination (☞ P.12).



# 3 Advanced Operations

## Menu List

● Menu Setting (while the recorder is stopped, press the **OK/MENU** button)

| Main Menu                                                                                         | Second layer | Setting                                                        | Ref. Page |
|---------------------------------------------------------------------------------------------------|--------------|----------------------------------------------------------------|-----------|
| <br>File Menu    | Pending      | <b>Finished</b> , Pending                                      | P.51      |
|                                                                                                   | Lock         | <b>Off</b> , On                                                | P.50      |
|                                                                                                   | Priority     | <b>Cancel</b> , Set                                            | P.52      |
|                                                                                                   | Work Type    | Edit the Work Type and Option Item.                            | P.53      |
| <br>Record Menu  | Rec Mode     | <b>QP</b> , SP                                                 | P.32      |
|                                                                                                   | VCVA         | <b>Off</b> , On                                                | P.33      |
|                                                                                                   | Mic Sense    | <b>Dictation</b> , Conference                                  | P.31      |
| <br>Display Menu | Backlight    | <b>On</b> , Off                                                | P.59      |
|                                                                                                   | LED          | <b>On</b> , Off                                                | P.60      |
|                                                                                                   | Contrast     | Program contrast level 1~12 (Default is <b>6</b> ).            | P.61      |
|                                                                                                   | Language     | <b>English</b> , Deutsch, Français, Español, Italiano, Русском | P.58      |
| Device Menu<br>(To the next page)                                                                 |              |                                                                |           |

| Main Menu                                                                                        | Second layer       | Setting                                                   | Ref. Page |
|--------------------------------------------------------------------------------------------------|--------------------|-----------------------------------------------------------|-----------|
| <br>Device Menu | <b>Fingerprint</b> | <b>Enroll, Verify</b>                                     | P.48      |
|                                                                                                  | Card Select        | <b>SD</b> , microSD                                       | P.26      |
|                                                                                                  | Beep               | <b>On</b> , Off                                           | P.62      |
|                                                                                                  | Format             | Initializes the card ( <b>SD</b> /microSD).               | P.64      |
|                                                                                                  | USB Class          | <b>Composite</b> , Storage                                | P.67      |
|                                                                                                  | Time & Date        | In order of hour, minute, year, month and day.            | P.24      |
|                                                                                                  | Power Save         | In order of 5min., <b>10min.</b> , 30min., 1hour and Off. | P.22      |
|                                                                                                  | Reset Settings     | Returns the menu settings to their initial state.         | P.65      |
|                                                                                                  | Card Info.         | SD(Remain, Capacity), microSD(Remain, Capacity)           | P.13      |
|                                                                                                  | System Info.       | Model Name, Version, Serial                               | P.66      |
| File Menu<br>(To the page 41)                                                                    |                    |                                                           |           |

## Notes

- The selectable language varies depending on the countries where the product was purchased.
- [Fingerprint] is a menu item for the DS-5000iD only (it will not appear on the DS-5000).
- Items appear in bold letters in the "Setting" column to indicate that they are the initial settings.

# Learning to Use the Menu

To navigate through the different options in the Menu, use the Menu List flow chart (P.41,42) and the following steps to modify or change any settings.

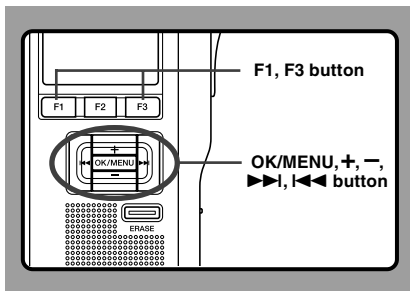

- 1 Press the OK/MENU button.**  
The [Main Menu] screen will appear on the display (P.41).

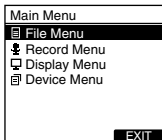

- 2 Press the + or - button to move to [Main Menu] item to be set.**

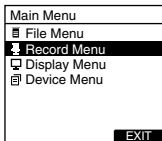

- 3 Press the OK/MENU or >>> button.**  
Move to the setting of the selected menu items.

- 4 Press the + or - button to move to the menu item to be set.**

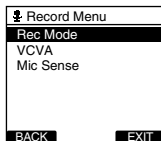

- 5 Press the OK/MENU or >>> button.**  
Move to the setting of the selected item.

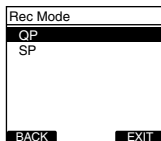

- 6 Press the + or - button to change the setting.**

- 7 Press the OK/MENU button to complete the setup screen.**

If press the <<< or F1(BACK) button, the setting will be cancelled and it will return to the menu.

Pressing the F3(EXIT) button will cancel the contents being set and take you out of the MENU.

- 8 Press the F1(BACK) or <<< button to return to the [Main Menu] screen, then press the F3(EXIT) or <<< button to complete the setting.**

# Selecting Folders and Files

3

Selecting Folders and Files

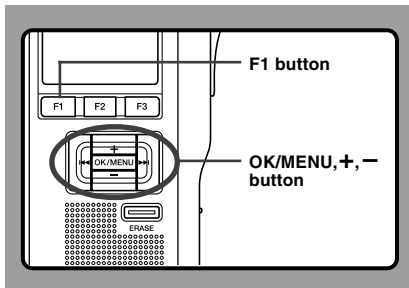

## Changing Folders

- 1 While the recorder is stopped, press the **F1 (FOLDER)** button.

The folder list screen will be displayed.

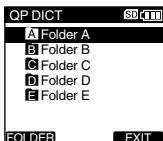

- 2 Press the **+** or **-** button to select the folder, then press the **OK/MENU** button.

This will change the folder.

You can switch folders by pressing the F1(FOLDER) button.

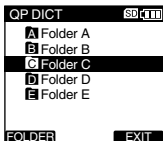

## Changing File

- 1 While the file is being displayed, press the **▶▶** or **◀◀** button.

This will change and display the file number order for files within the folder.

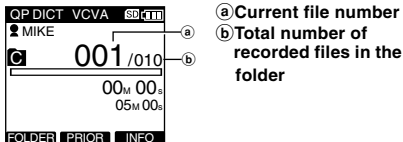

## Scroll bar

The scroll bar will appear when all of the items cannot be displayed in the menu or list display screen.

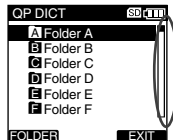

# Displaying File Information

The recorder can display a variety of information related to the current file.

It is also possible to go to the Work Type and Option Item edit screen.

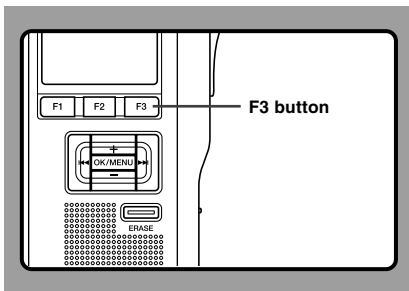

## The Displayed Information

The following information will be displayed.

**[File Name]**...File name

**[Rec Time]**...Time and date the file was recorded.

**[Author ID]**...Display the Author ID of file.

**[Work Type]**...Displays the Work Type ID of file.

**[Option Item]**...Displays the Option Item which has been set.

### 1 Select the file whose information you want to display.

Refer to P.44 regarding file selection.



### 2 Press the F3(INFO) button.

The file information is displayed.

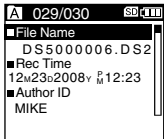

# Device Lock Function

Recorder access can be restricted by enabling the device lock function. Authentication via password and/or fingerprint verification (DS-5000iD only) can act as a safe guard for your data even in case the recorder is lost or left unattended. Fingerprint registry (☞ P.47) is performed by the recorder, while password registry can be performed by using DSS Player (☞ P.69).

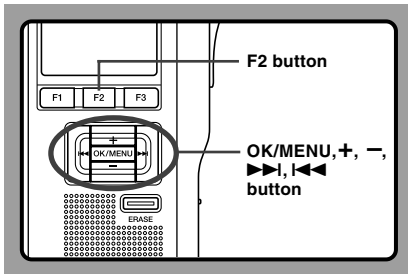

## Unlocking the Recorder

When the password registry and/or fingerprint registry is done, the recorder will prompt for password and/or fingerprint verifications (DS-5000iD only) on startup.

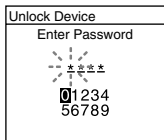

DS-5000

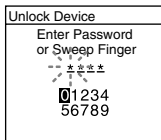

DS-5000iD

Unlock the recorder's device lock through the method below.

The default password when using the recorder for the first time is "0000".

## Unlocking the Recorder with a Password

- 1 Select the numbers you want to enter by pressing the +, -, >>> or <<< button to move the cursor.

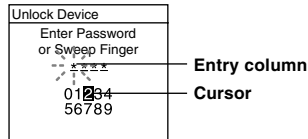

- 2 Press the OK/MENU button to select a number.

A \* will appear in the selected first digit and the blinking cursor will move to the next one over (to the right). Repeat steps 1 and 2 to enter all four digits.

Pressing the ERASE button at any time will erase the last entry and move the cursor to the previous entry (to the left).

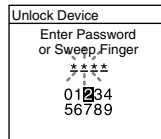

- 3 After all four digits have been entered, press the F2(ENTER) button.

If the 4 digit number entered matches the registered password then the startup message will appear and the recorder will start up.



## Unlocking the Recorder Via Fingerprint Verification (Only DS-5000iD)

Slide the finger to be scanned for verification over the scanner window on the back side of the recorder in one sweeping motion from top down as shown in the illustration.

If [NG! Sweep Finger Again] is displayed, re-scan your finger or a different registered finger again. If there is no fingerprint match after 10 tries [Incorrect Fingerprint Enter Password] will be displayed and it is not possible to authenticate via fingerprint verification.

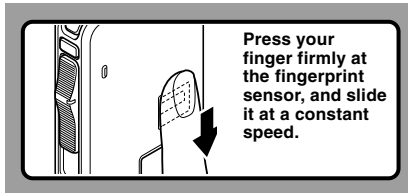

In case the fingerprint may not be scanned correctly, press your finger firmly against the sensor and sweep it.

## How to Scan the Fingerprint

- Place your finger as shown in the diagram and start scanning from a state where the first joint of your finger is touched to the fingerprint sensor.
- Pressing the finger securely, and slide from the first joint of your finger to fingertip properly on the sensor in direction of the arrow approximately 1 second at a constant speed.

- Slide straight the finger to the center of the fingerprint sensor without winding.
- While sliding, do not move the finger away from the sensor.

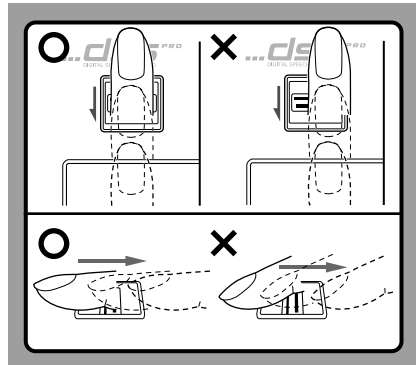

## Notes

The register and verification of the fingerprint may have difficulties in below cases.

- The state of finger is as follows:
  - Using the other registered finger or after washing the hand, it may improve.
  - When the finger is dry.
  - When the finger got swollen such as just after taking a bath.
  - When the finger is either sweaty and greasy or wet.
  - When the finger has a rough skin or is injured..
  - When the finger is dirty.
  - When the fingerprint is light and wrinkly.
- When the direct sunlight or strong light gets to the fingerprint sensor.
- When the fingerprint sensor is dirty.
  - Wipe off with a soft cloth etc.

### Authentication Halt Mode

If there is no password match after five tries the recorder will enter password input halt mode for ten minutes. After ten minutes have passed the mismatch history will be erased and it will once again return to the password input screen.

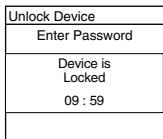

### Fingerprint Registration (Fingerprint)

Fingerprint registration is performed on the recorder. By selecting an Author ID from the Author list (P.53) and then registering your fingerprint, you can associate it to your Author ID. You can register up to 10 fingerprint data.

- 1 **Select [Fingerprint] at the [Device Menu] screen, then press the OK/MENU or ►► button.**

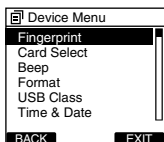

- 2 **Press + or - button to select [Enroll], then press the OK/MENU or ►► button.**

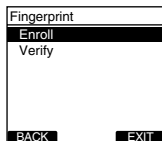

- 3 **Press the + or - button to select a registration number, then press the OK/MENU or ►► button.**

When making a new registration, select a registration number that has not already been registered (Ⓜ does not appear). When re-registering a fingerprint, select the previously registered number (Ⓜ does appear).

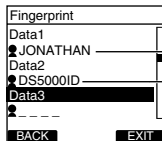

- a **Connection with Author ID**
- b **No connection with Author ID**

When re-registering, the re-registration confirmation screen will appear and you can select [Yes] to continue with registration.

- 4 **Recognizing your fingerprint (P.47).** [OK] will appear when the fingerprint is recognized correctly. When the fingerprint data is recognized 3 times, [Completed] appears and the fingerprint data is registered.

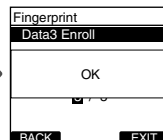
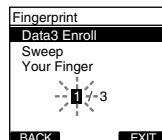



When the below error message appeared, scan again while referring “How to Scan the Fingerprint” (P.47) carefully.

**[Sweep Error Sweep your finger again]**...Displays when the fingerprint is not recognized correctly.  
**[Sweep Error Sweep your finger with care]**...Displays when the recognized fingerprint data does not match.

### Verifying the Registered Fingerprint Data

- 1 Select **[Fingerprint]** at the **[Device Menu]** screen, then press the **OK/MENU** or **▶▶** button.
- 2 Press the **+** or **-** to button select **[Verify]**, then press the **OK/MENU** button.
- 3 **Recognizing your fingerprint** (P.47). If your fingerprint data matches, **[Fingerprint Accepted]** will be displayed and the matching registration number will appear. In cases where there is a connection with an author, the Author ID will appear. If the fingerprint does not match, then **[Incorrect Fingerprint]** will appear and then it will return to the fingerprint scanning screen.

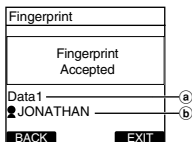

- a **Verified registration number**
- b **Related Author ID**

### Erasing Fingerprint Data

- 1 Select the registration number you want to erase, then press the **ERASE** button. The method for Step 1 on P.48 will appear on the registration number list screen.
- 2 Press the **+** or **-** to select **[Yes]**, then press the **OK/MENU** button.

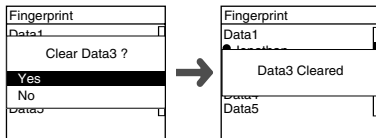

The erasing of the selected registration data will be completed.

### Note

- Fingerprint registration and verification in this recorder cannot guarantee the entire security. We are not responsible for any damage or loss for use of fingerprint registration and verification of this recorder or even if you cannot use this function.

# Locking Files (Lock)

When a file is set to [Lock],  will appear on the display, allowing you to prevent important files from accidental erase. Moreover, the file will not be erased even when all files within a folder are erased.

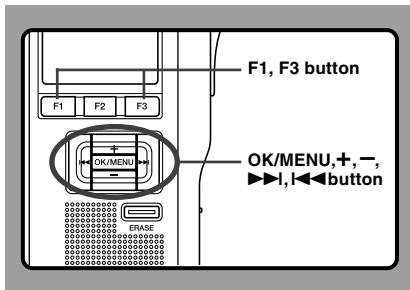

- 1 Select the file you want to Lock.
- 2 Select [Lock] at the [File Menu] screen, then press the OK/MENU or >>> button. Refer to P.41 regarding each menu item settings.

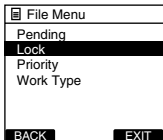

- 3 Press the + or - button to select [On] or [Off].  
On...Locks the file and prevents it from being erased.  
 appears on the display.  
Off...Unlocks the file and allows it to be erased.

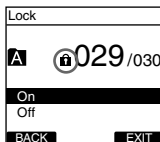

- 4 Press the OK/MENU button to complete the setup screen.  
[File Lock ON] or [File Lock OFF] will light up on the display, and it will return to the [File Menu] screen.  
If press the <<< or F1(BACK) button the setting will be cancelled and it will return to the [File Menu]. Pressing the F3(EXIT) button will cancel the contents being set and take you out of the MENU.

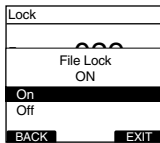

- 5 Press the F1(BACK) or <<< button to return to the [Main Menu] screen, then press the F3(EXIT) or <<< button to complete the setting.



# Pending Files (Pending)

When you set [Pending] to the file, the file becomes “Pending file” and the editing sign of ✎ will appear on the display. If “Download file” is set to “Finished file” by DSS Player, the [Pending] file is not transferred and only [Finished] file (edited file) will be transferred to your PC.

For details, see “Dictation settings” in the “Customizing the Recorder” (☞ P.68).

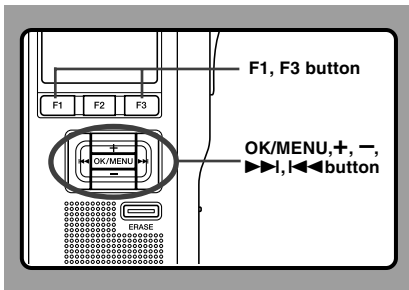

- 1 Select [Pending] at the [File Menu] screen, then press the OK/MENU or >>>| button. Refer to P.41 regarding each menu item settings.

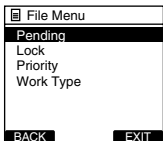

- 2 Press the + or - button to select [Pending] or [Finished].

**Pending...**Sets to a file of “Editing” and ✎ appears on the display.

**Finished...**Sets to a file of “already edited”.

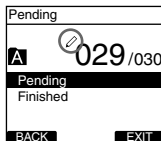

- 3 Press the OK/MENU button to complete the setup screen.

[Pending Set] or [Finished Set] will light up on the display, and it will return to the [File Menu] screen.

If press the <<< or F1(BACK) button the setting will be cancelled and it will return to the [File Menu].

Pressing the F3(EXIT) button will cancel the contents being set and take you out of the MENU.

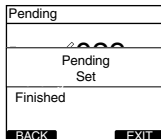

- 4 Press the F1(BACK) or <<< button to return to the [Main Menu] screen, then press the F3(EXIT) or <<< button to complete the setting.



# Setting Priority Levels (Priority)

3

Setting Priority Levels

By default, F2 button is programmed with Priority function. The setting can also be performed from the menu.

You can set a priority level on each file recorded. You can choose between "HIGH" and "NORMAL" The default is Normal level.

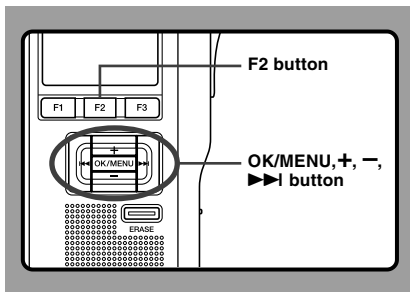

## Performing the Setting from the Menu

- 1 Select the file which you would like to set the Priority level for.
- 2 Select [Priority] at the [File Menu] screen, then press the **OK/MENU** or **>>>** button.

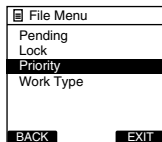

- 3 Press the **+** or **-** button to select [Set] or [Cancel], then press the **OK/MENU** button.  
[Set]...High Level.  
[Cancel]...Normal Level.

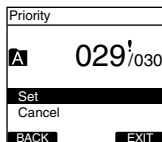

## To Set a Priority Level on a File

### To Set the F2(PRIOR) Button

- 1 Select the file you want to perform the setting on, then press the **F2(PRIOR)** button.

Each time the F2(PRIOR) button is pressed the Priority level will change (HIGH/NORMAL). When the HIGH level setting is selected, **!** will appear on the display.

Perform the setting in the same manner after creating a NEW file.

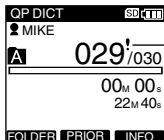

ⓐ Priority indicator

# Setting the Author ID and Work Type

Every file recorded on the recorder will include the Author ID and Work Type as part of its header information. To create multiple Author IDs and Work Types on the recorder, use the bundled DSS Player software to create and upload a Data list (list of Author IDs and Work Types) to the recorder. For more details, refer to the online help for DSS Player (P.73). By default the Author ID is set to "DS5000".

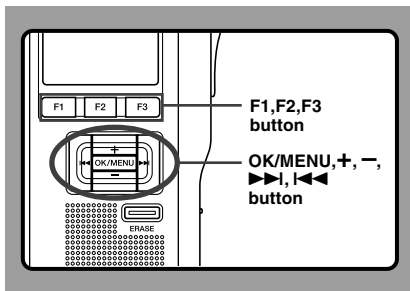

## Setting an Author ID

### 1 Turn ON the recorder.

When [The Author List is displayed when the power is on.] has been set through DSS Player (P.69), the registered Author ID List will appear.

### 2 Press the + or - button to select the Author ID that you want to assign to the recorder from the ID list.

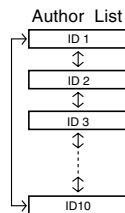
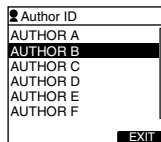

### 3 Press the OK/MENU button to set the ID.

When more than one Author ID exist on the recorder, the ID list will be displayed.

## Note

- Up to 10 Author ID entries can be registered (up to a maximum of 16 characters).

## Setting the Work Type

Up to 10 Work Types can be registered in the DSS Player software and uploaded to the recorder. Each Work Type can have up to 10 Option Items associated with it. The Work Types and Option Items can be used on the recorder to populate the recording file header information. Refer to the online help for DSS Player (P.73) regarding registration/set up details and Option Item through DSS Player.

### 1 While the recorder is stopping mode, press the NEW button.

When [The Worktype List is displayed when a new file is created.] has been set through DSS Player (P.69), the Work Types uploaded to the recorder will appear in a list.

### 2 Press the + or - button to select a Work Type from the Work Type list.

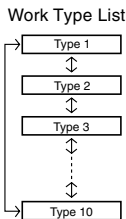
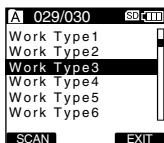

### 3 Press the OK/MENU button to select the Work Type.

The selected Work Type and a maximum of 10 Option Items registered for that Work Type will be recorded in the New File header information. When the item of Option Item Label within the selected Work Type is possible to set for Value input, it will take you to the file information input screen (P.55). For more details, refer to the online help for DSS Player (P.73).

## Editing the Work Type

The Work Type information of the recorded or uploaded files can be edited with the menu settings of the recorder (P.41)

### 1 Select the file you want to edit its Work Type information (P.45).

### 2 Select [Work Type] at the [File Menu] screen, then press the OK/MENU or ► button.

The Work Type setting screen will appear.

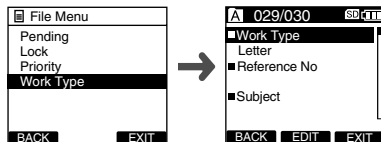

### 3 Press the F2(EDIT) button. The modification method confirmation screen will appear.

### 4 Press the + or - button to select [Edit Work Type] or [Select From Work Type List], then press the OK/MENU button.

**Edit Work Type...** This will take you to the file information input screen (P.55) and allow you to modify the Work Type information that has been recorded for the file.  
**Select from Work Type List...** You can re-select Work Type from the Work Type list.

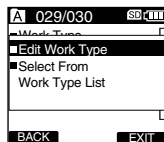

## Inputting Option Item Value

- 1 Press the **+** or **-** button on the file information input screen to select the targeting Option Item, then press the **OK/MENU** button.

The input screen will be displayed.

When inputting an Option Item value into a new file or the file with a re-selected Work Type, only eligible input characters as specified in the DSS Player can be entered.

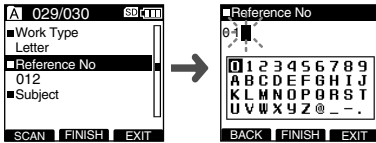

File information input screen

Option Item value input screen

- 2 **Entering characters.**  
Enter characters through the following method.

### ● Character selection

**+, -, ◀, ▶ button...** Select the character string (numbers, alphabets or symbols) displayed in the Keyboard window to move the cursor up, down, left and right by pressing.

### ● Character confirmation

**OK/MENU button...** Use this button to confirm your selection.

### ● Moving the entry column

When pressing the **+** button if the cursor is on top of the Keyboard window, the cursor will disappear. An Entry column within the input value display area will change from flashing to lighting. The Entry column can be moved when it is lit.

**▶▶ button...** Each press of the button moves the Entry column one space to the next (right). The Entry column can be moved up to the space next (right) to the last character.

**◀◀ button...** Each press of the button moves the Entry column one space to the previous (left). The Entry column can be moved up to the first character.

**- button...**The Entry column changes from lighting to flashing. The cursor is lit on the "0" string within the keyboard Window, and makes character selection available.

Entry is performed by insert entry. When the character in the Entry column has already been finalized, the character after the cursor will move one column to the right.

### ● Maximum entered character count

The Option item value can be entered up to the number of characters specified below. Preset default values can also be set for the option items to simplify data entry process.

**Option Item Value...** 20 characters

### ● Cancelling the entered contents

**Press the F1(BACK) button to select [YES], then press the OK/MENU button during entry...**This will erase the entered contents for this item and return you to the File information input screen.

**Press the F3(EXIT) button to select [YES], then press the OK/MENU button during entry...** This will erase all of the finalized contents for the items, and the recorder will return to stopped state in the New file or the state before entering Menu settings.

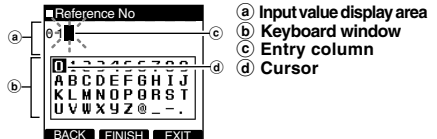

- 3 **Press the F2(FINISH) button.**  
While creating a New File, selected Option Item Value input appears at the bottom of Option Item Value.  
When the F2 (FINISH) button is pressed, it will take you to the stopped state in the New File.

3 Setting the Author ID and Work Type

# Verbal Comment

3

Verbal Comment

The data recorded with the F1(VERBAL) button being pressed during recording, is recorded as a Verbal comment position (a position within a file) in the header.

It is possible to instantly search and play back Verbal comment sections through DSS Player, thereby making it useful for things like giving instructions to transcriptionists.

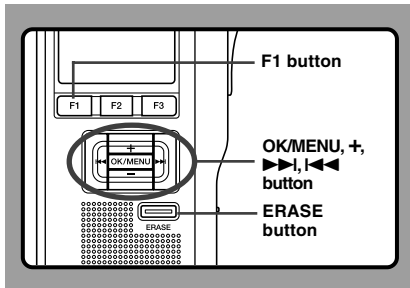

## Setting a Verbal Comment

- 1 While the recorder is recording mode, press and hold the **F1 (VERBAL)** button, then release it when you want to stop. Audio recorded while continuing to hold the F1(VERBAL) button will be recorded as Verbal Comment.

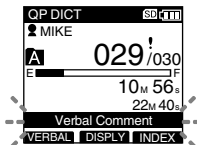

## Locating a Verbal Comment

- 2 While playing back a file, press and hold the **>>>|** or **|<<<** button.

The recorder stops for 1 second when it reaches the Verbal Comment.



## Clearing an Verbal Comment

- 3 While playing a Verbal Comment, press the **ERASE** button.

- 4 Press the **+** button to select [Clear], then press the **OK/MENU** button. The Verbal Comment is erased.

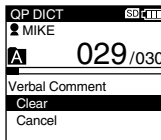

## Notes

- Up to 32 Verbal Comment can be set in a file.
- When a file is locked or set to read-only, or when the SD card lock is enabled Verbal Comment cannot be erased. Clear the settings before erasing.
- When the recorder has been set to Classic DSS mode Verbal comments cannot be recorded. For details, see "Dictation settings" in the "Customizing the Recorder" (P.68).



# Index Marks

Index marks can be placed in a file during recording or playback. Index marks are used to provide a quick and easy way to identify important or significant parts within the file.

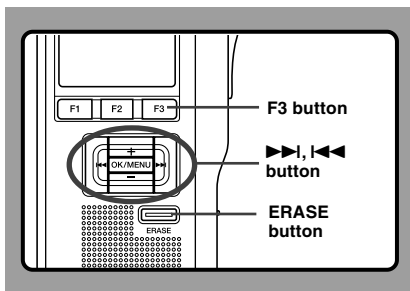

## Setting an Index Mark

- 1 While the recorder is recording or playing back mode, press the **F3(INDEX)** button to set an index mark.

An index number appears on the display.

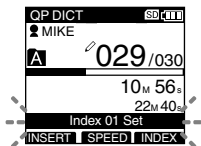

## Locating an Index Mark

- 2 While playing back a file, press and hold the **▶▶** or **◀◀** button.

The recorder stops for 1 second when it reaches the index mark.

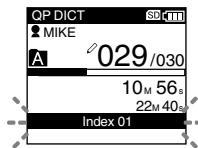

## Clearing an Index Mark

- 3 Locate the index mark you want to clear.

- 4 While the index number appears for approximately 2 seconds on the display, press the **ERASE** button

The index mark is erased.

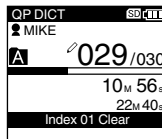

## Notes

- Up to 32 indexmark can be set in a file.
- When a file is locked or set to read-only, or when the SD card lock is enabled Indexmark Comment cannot be erased. Clear the settings before erasing.
- When the recorder has been set to Classic DSS mode index marks are limited to a maximum of 16 for each file. For details, see "Dictation settings" in the "Customizing the Recorder" (P.68).

# Language (Language)

You can select the display language for this recorder.

The selectable language varies depending on the countries where the product was purchased.

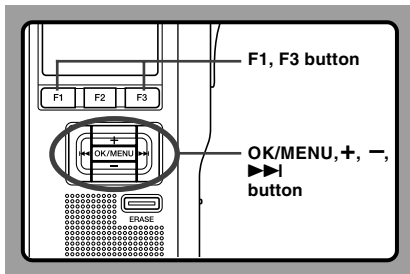

- 1 Select [Language] at the [Display Menu] screen, then press the OK/MENU or >>> button.

Refer to P.41 regarding each menu item settings.

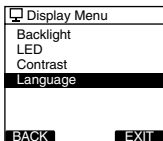

- 2 Press the + or - button to set the language.

**English**...Displays in English.  
**Deutsch**...Displays in German.  
**Français**...Displays in French.  
**Español**...Displays in Spanish.  
**Italiano**...Displays in Italian.  
**Русский**...Displays in Russian.

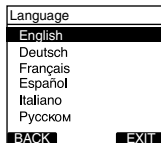

- 3 Press the OK/MENU button to complete the setup screen.

The displayed language is changed and will return to the [Display Menu] screen.

If press the <<< or F1(BACK) button the setting will be cancelled and it will return to the [Display Menu].

Pressing the F3(EXIT) button will cancel the contents being set and take you out of the MENU.

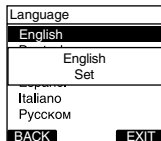

- 4 Press the F1(BACK) or <<< button to return to the [Main Menu] screen, then press the F3(EXIT) or <<< button to complete the setting.

## Note

- The selectable language varies depending on the countries where the product was purchased.

# Backlight (Backlight)

When the display backlight is set to [On], the backlight will light up for about 10 seconds when a button is pressed.

This is useful in that it allows you to check the display even in dark locations.

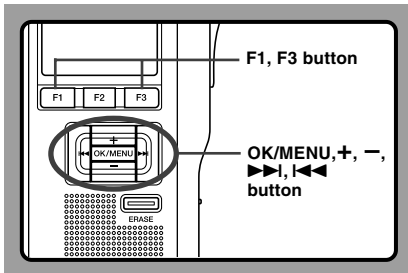

- 1 **Select [Backlight] at the [Display Menu] screen, then press the OK/MENU or >>> button.**

Refer to P.41 regarding each menu item settings.

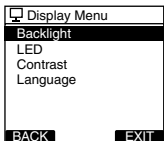

- 2 **Press the + or - button to select [On] or [Off].**

**On...**Backlight is enabled.

**Off...**Backlight is disabled.

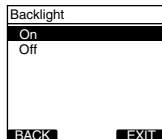

- 3 **Press the OK/MENU button to complete the setup screen.**

[On Set] or [Off Set] will light up on the display, and it will return to the [Display Menu] screen.

If press the <<< or F1(BACK) button the setting will be cancelled and it will return to the [Display Menu].

Pressing the F3(EXIT) button will cancel the contents being set and take you out of the MENU.

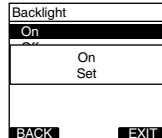

- 4 **Press the F1(BACK) or <<< button to return to the [Main Menu] screen, then press the F3(EXIT) or <<< button to complete the setting.**

# LED (LED)

You can set it so the Record/Play indicator light does not turn on.

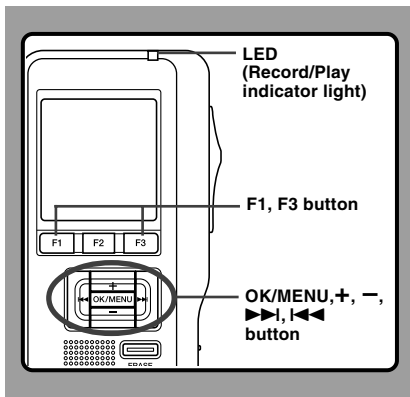

- 1 Select [LED] at the [Display Menu] screen, then press the **OK/MENU** or **>>>** button.

Refer to P.41 regarding each menu item settings.

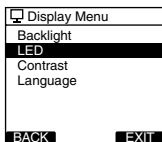

- 2 Press the **+** or **-** button to select [On] or [Off].

**On**...LED light will be set.

**Off**...LED light will be cancelled.

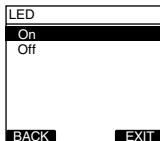

- 3 Press the **OK/MENU** button to complete the setup screen.

[On Set] or [Off Set] will light up on the display, and it will return to the [Display Menu] screen.

If press the **<<<** or F1(BACK), the setting will be cancelled and it will return to the [Display Menu]. Pressing the F3(EXIT) button will cancel the contents being set and take you out of the MENU.

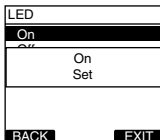

- 4 Press the **F1(BACK)** or **<<<** button to return to the [Main Menu] screen, then press the **F3(EXIT)** or **<<<** button to complete the setting.

# LCD Contrast Adjustment (Contrast)

Display contrast can be adjusted from level 01 to 12.

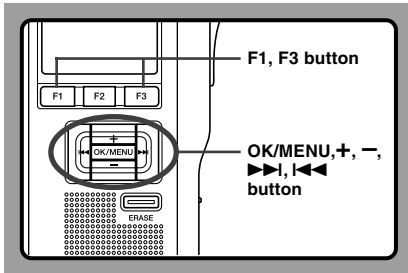

- 1 Select [Contrast] at the [Display Menu] screen, then press the **OK/MENU** or **>>>** button.

Refer to P.41 regarding each menu item settings.

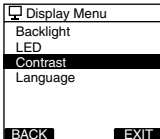

- 2 Press the **+** or **-** button to set the contrast level.

You can adjust the LCD display contrast level from 1 to 12.

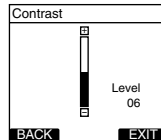

- 3 Press the **OK/MENU** button to complete the setup screen.

The set contrast level lights up and will return to the [Display Menu] screen.

If press the **<<<** or **F1(BACK)**, the setting will be cancelled and it will return to the [Display Menu]. Pressing the **F3(EXIT)** button will cancel the contents being set and take you out of the MENU.

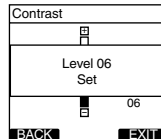

- 4 Press the **F1(BACK)** or **<<<** button to return to the [Main Menu] screen, then press the **F3(EXIT)** or **<<<** button to complete the setting.

# System Sounds (Beep)

When this is set to [On], the recorder beeps to alert you to button operations or warn you of errors.

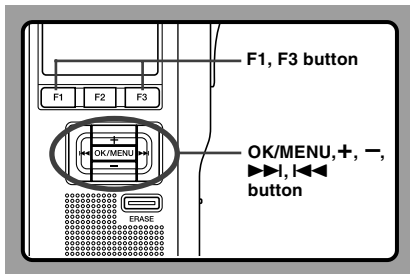

- 1 Select [Beep] at the [Device Menu] screen, then press the **OK/MENU** or **>>>** button.

Refer to P.42 regarding each menu item settings.

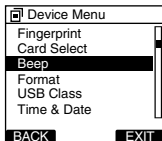

- 2 Press the **+** or **-** button to select [On] or [Off].

**On**...System sounds are enabled.

**Off**...System sounds are disabled.

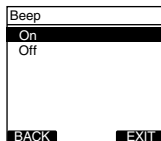

- 3 Press the **OK/MENU** button to complete the setup screen.

[On Set] or [Off Set] will light up on the display, and it will return to the [Device Menu] screen.

If press the **I<<<** or **F1(BACK)** button the setting will be cancelled and it will return to the [Device Menu].

Pressing the **F3(EXIT)** button will cancel the contents being set and take you out of the MENU.

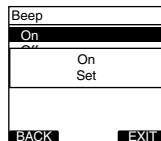

- 4 Press the **F1(BACK)** or **I<<<** button to return to the [Main Menu] screen, then press the **F3(EXIT)** or **I<<<** button to complete the setting.

# Inserting and Ejecting a microSD card

When it is necessary to remove or insert the microSD card serving as the built-in memory in emergencies, use the method below to either remove or insert it.

## Inserting a microSD card

- ① Open the battery cover (see P.16).
- ② Open the card cover inside the battery compartment.
- ③ Insert the microSD card into the card slot in the direction shown in the illustration until it clicks.

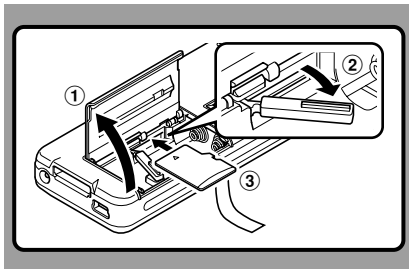

## Ejecting a microSD card

- ① Open the battery cover (see P.16).
- ② Open the card cover inside the battery compartment.
- ③ Push the microSD card inward once to unlock it, and let it eject.

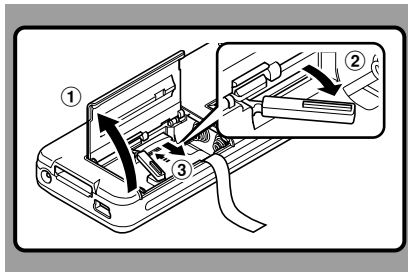

## When it is Difficult to Eject the microSD card

The microSD card is sometimes difficult to take out. In this case, pick up a card with your fingers as shown in the illustration. Exercise caution when using things like tweezers, as there is the risk of accidentally damaging the card and rendering it unable to read data out.

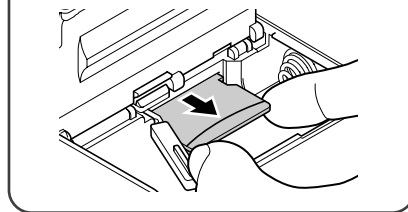

# Formatting the Card (Format)

3

Formatting the Card

Cards that have been used in non-Olympus devices, or cards that are not recognized by the recorder, must be formatted before they can be used with the recorder.

To familiarize yourself with the formatting process, read the steps below.

In terms of formatting, only selected cards can be formatted, the recorder's menu settings cannot be initialized. The initialization of menu items should be set up through DSS Player or the recorder's [Reset Settings].

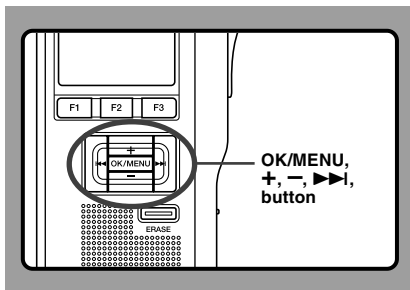

- 1 **Select [Device Menu] at the [Format] screen, then press the **OK/MENU** or **▶▶** button.**

Refer to P.42 regarding the menu's various setting items.

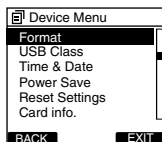

- 2 **Press the **+** or **-** button to select [SD] or [microSD], then press the **OK/MENU** button.**

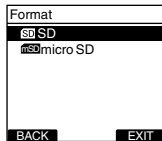

- 3 **Press the **+** or **-** button to select [Start] option.**

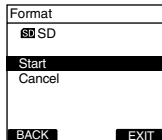



4 Press the **OK/MENU** button to confirm [Start] selection.

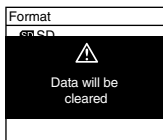

5 Press the **+** or **-** button again to select [Start] option.

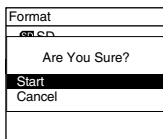

6 Press the **OK/MENU** button again to initiate the formatting process.

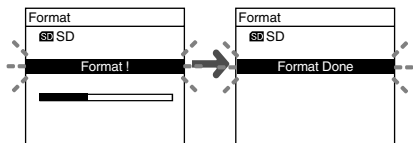

[Format Done] displays when formatting ends.

## Initializing the Recorder's Menu Settings (Reset Settings)

To return the recorder's menu settings to their original status from the time of purchase (initial settings), perform the setting from [Reset Settings] in the [Device Menu], or perform the same operation by using DSS Player.

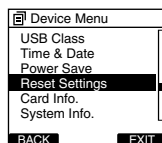

## Notes

- The time required to format cards differs depending on the capacity of cards. Do not interrupt the formatting process by the following operations. Doing so will damage the data or card.
  - Remove the card.
  - Remove the batteries.
- When the card is formatted, all the stored data, including locked files, are erased.
- If an unformatted card is inserted, the recorder automatically displays the format option in the menu.
- SD cards for which the SD card lock is enabled cannot be initialized.
- Formatting on the recorder will be Quick Format. If you format the card, information of file management is refreshed and the data inside the card is not deleted completely. When handing over and disposing the card, be careful about the data leakage from the card. We recommend the card to be destroyed when you dispose the card.

# Check System Information (System info.)

System information about the recorder like its [Model Name], [Version] and [Serial] can be displayed.

In this recorder, you can check the Card Information (☞ P.13) and File Information (☞ P.45).

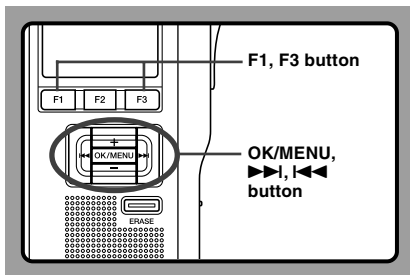

3

Check System Information

- 1 Select [System info.] at the [Device Menu] screen, then press the **OK/MENU** or **>>>** button.

[Model Name] [Version] [Serial] will appear.

Refer to P.42 regarding each menu item settings.

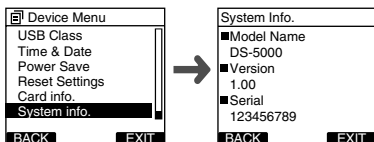

- 2 Press the **OK/MENU**, **<<<** or **F1 (BACK)** button.

When you press the F3 (EXIT) button, it will return to the previous display from MENU.

- 3 Press the **F1 (BACK)** or **<<<** button to return to the [Main Menu] screen, then press the **F3 (EXIT)** or **<<<** button to complete the setting.

# Changing the USB Class (USB Class)

You can set the USB class of this recorder with a USB connection to [Composite] or [Storage]. Set to [Composite] when using this recorder as a USB speaker or a USB microphone.

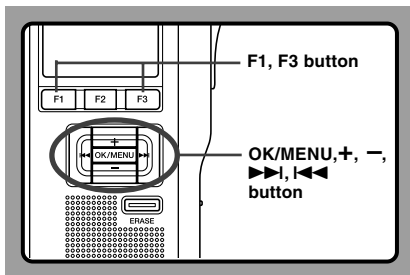

- 1 Select [USB Class] at the [Device Menu] screen, then press the OK/MENU or >>> button.

Refer to P.42 regarding each menu item settings.

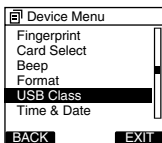

- 2 Press the + or - button to select [Composite] or [Storage].

**Composite...**In the 3 classes of Storage, USB audio and human interface, USB connection is possible.

While USB connection in [composite], the recorder can be used as the USB speaker and the USB microphone.

**Storage...**USB connection is possible in only Storage class.

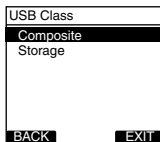

- 3 Press the OK/MENU button to complete the setup screen.

[Composite Set] or [Storage Set] will light up on the display, and it will return to the [Device Menu] screen.

If press the <<< or F1(BACK) button the setting will be cancelled and it will return to the [Device Menu].

Pressing the F3(EXIT) button will cancel the contents being set and take you out of the MENU.

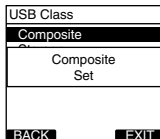

- 4 Press the F1(BACK) or <<< button to return to the [Main Menu] screen, then press the F3(EXIT) or <<< button to complete the setting.

When this recorder is connected to the computer for the first time after being changed to "Remote(Composite)", the driver will be installed automatically to the computer.

# Customizing the Recorder

---

You can customize various specifications of the recorder when using DSS Player (☞ P.69). For more details, refer to the online help for DSS Player (☞ P.73).

## The Recorder's Customized Settings

### ❑ Button settings

You can change the allocated functions for the Programmable Smart Buttons (F1, F2, F3 buttons), the NEW button, and the slide switch.

### ❑ Hands-Free settings

You can perform settings related to the Hands-Free operation with the Foot Switch (RS27/28 sold optional).

### ❑ Menu settings

You can set the default values for each of the recorder's Menu items.

### ❑ Security settings

You can perform various settings related to the recorder's device lock.

- Device lock function ON/OFF.
- Settings related to the timing for setting the device lock.
- Password settings.
- Changing the number of allowable input errors (mismatches) for the password.

### ❑ Author List settings

You can perform settings related to the Author, such as Author registration.

### ❑ Work Type List settings

You can perform settings related to the Work Type, such as Work Type registration.

### ❑ Folder settings

You can perform various settings related to the recorder's folders.

- Changing the number of folders and folder name.

- Auto Lock setting which locks files recorded in designated folders.
- Encryption Password setting which encrypts files recorded in designated folders.
- Work Type settings for each folder.

### ❑ Dictation settings

You can perform various settings related to the recorder's Dictation.

- Recording format (DSS Pro/Classic DSS) selection.
- Recording mode (Overwrite/Append/Insert) setting.
- Settings related to eligible files when downloading to a PC (All Files/Finished Files).

### ❑ Alarm settings

You can set occasions for the recorder's alarm or beep noise to sound.

### ❑ Slide Switch Guide settings

You can set the Slide Switch Guide, which indicates the position of the Slide Switch on the recorder's LCD screen, to either enabled or disabled.

### ❑ Permission settings

You can perform various settings related to user authorization, such as prohibiting both file erasure and MENU settings.

### ❑ Splash Message settings

You can set the contents that appear in the message which is displayed during startup.

### ❑ Display settings

- You can select a default pattern for display during recording from 5 patterns.
- On the 2nd line of LCD, you can display File Name or Work Type instead of Author ID which is currently displayed in the NEW, STOP, REC, PLAY, CUE/REV, FF/REW or ERASE mode.

# 4 Managing Files on Your PC

## DSS Player Software

---

The DSS Player is a fully featured software tool that provides a simple to use but sophisticated method of managing your recordings. Some of the features of the DSS Player are:

- Automatic startup of the application by connecting the device.
- Automatic download of Dictation by connecting the device.
- Backs up downloaded Dictation (Windows only).
- Automatic transmission of downloaded Dictation to addresses specified through e-mail and FTP (Windows only).
- Automatic transmission of transcribed documents through e-mail and FTP, as well as Dictation and link management (Windows only).
- Voice recorder's menu setting.
- Customize functions on the recorder (Windows only).
- Direct recording and editing of existing Dictation through Voice recorder's button and slide operation.
- Recording Instruction Comments and Verbal comments (Windows only).
- Encrypt the Dictation within the folder by encrypting the folder itself (Windows only).

Make sure that your computer meets the minimum requirements listed below. Please check with your system administrator or your Olympus Professional Dealer.

## Minimum Requirement

---

### Windows

|                             |                                                                                                                                                                                                                                                                                                                                                                                                               |
|-----------------------------|---------------------------------------------------------------------------------------------------------------------------------------------------------------------------------------------------------------------------------------------------------------------------------------------------------------------------------------------------------------------------------------------------------------|
| <b>Operating System:</b>    | Windows 2000 Professional Service Pack4;<br>Windows XP Professional/XP Home edition Service Pack2;<br>Windows XP 64-bit;<br>Windows Vista Ultimate/Enterprise/Business/Home Premium/Home Basic;<br>Windows Vista Ultimate 64-bit edition/Enterprise 64-bit edition/Business 64-bit edition/Home Premium 64-bit edition/Home Basic 64-bit edition;<br>Windows Server 2003;<br>Windows Server 2003 x 64 edition |
| <b>CPU:</b>                 | Windows 2000/XP: 500MHz processor or more<br>Windows Vista: 800MHz processor or more<br>Windows Server 2003: 550MHz processor or more                                                                                                                                                                                                                                                                         |
| <b>RAM:</b>                 | Windows 2000/XP: 128MB or more<br>Windows Vista: 512MB or more<br>Windows Server 2003: 256MB or more                                                                                                                                                                                                                                                                                                          |
| <b>Hard drive space:</b>    | Dictation Module: 70MB or more;<br>Microsoft .NET Framework Version 2.0: 150MB                                                                                                                                                                                                                                                                                                                                |
| <b>Drive:</b>               | CD or DVD drive                                                                                                                                                                                                                                                                                                                                                                                               |
| <b>Display:</b>             | 800 x 600 pixels or more, 65536 colors more                                                                                                                                                                                                                                                                                                                                                                   |
| <b>USB port:</b>            | One or more free ports                                                                                                                                                                                                                                                                                                                                                                                        |
| <b>Audio I/O terminals:</b> | Windows-compatible sound device                                                                                                                                                                                                                                                                                                                                                                               |

### Macintosh

|                          |                                                               |
|--------------------------|---------------------------------------------------------------|
| <b>Operating System:</b> | Mac OS 10.3.9 - 10.5                                          |
| <b>CPU:</b>              | Power PC G3 500MHz or more/Intel Core Solo/Duo 1.5GHz or more |
| <b>RAM:</b>              | 256MB or more (512MB or more is recommended)                  |
| <b>Hard drive space:</b> | 200MB or more                                                 |
| <b>Display:</b>          | 1024 x 768 pixels or more, 32000 colors more                  |
| <b>USB port:</b>         | One or more free ports                                        |

---

### Note

- Macintosh version does not support voice recognition software.

# Installing DSS Player Software

**Be sure to confirm the following before installation:**

- Exit all running applications.
- Eject the floppy disk if you are using one.
- If you are running Windows 2000/XP/Vista or Mac OS X on the network, you need to log on as an Administrator.

## Windows

For the Windows version, there is an installation method for individuals and one for administrators to install on multiple client PCs. An explanation of the installation method for individuals installing the software on a single PC will be provided here.

### 1 Insert Olympus DSS Player CD into the CD-ROM drive.

The installation program will start automatically. If the installation program does not start automatically, browse your CD-ROM drive and execute "launcher.exe".

### 2 The launcher will startup.

Select the language you would like to install from the upper-left pull-down menu and click [DSS Player Pro Installation].

### 3 The Install Wizard will begin.

Once you have consented to the licensing agreement, enter your name, company name, and license ID number (serial number). The license ID number is printed on the license ID card included inside the recorder package.

### 4 Proceed with the installation according to the instructions on the screen.

## Macintosh

### 1 Insert Olympus DSS Player CD into the CD-ROM drive.

### 2 Double-click the CD icon.

### 3 Double-click the setup icon.

The Install Wizard will begin. Once you have consented to the licensing agreement, follow the instructions on the screen to complete the installation.

### 4 Proceed with the installation according to the instructions on the screen.

### 5 You will be requested to restart, so conduct a restart by following the instructions.

# Uninstalling DSS Player Software

---

## Windows

- 1 Exit DSS Player program.
- 2 Click the [start] button on the taskbar.
- 3 Select [Add/Remove programs] from the [Control Panel].  
A list of installed applications is displayed.
- 4 Select [Olympus DSS Player Pro], then click the [Change/Remove] button.
- 5 Proceed with the uninstallation according to the instructions on the screen.

## Macintosh

- 1 Exit DSS Player program.
- 2 Double-click “DSS Uninstaller” in [Application] → [DSS Player] folder.  
An uninstaller is displayed.
- 3 Proceed with the uninstallation according to the instructions on the screen.

---

### Note

- The dictation files you made are stored in the [MESSAGE] folder. If you don't need them, delete them. You can confirm the location of the [MESSAGE] folder by clicking on [Options] in the [Tools] menu before uninstalling.



# Using Online Help

---

For information on the DSS Player usage and features, refer to the online Help.

**To start online Help:**

## Windows

- 1 Click the [start] button, then select [All Programs], [Olympus DSS Player], [Dictation Help].
- 2 While DSS Player is running, select the [Help] menu, [Contents].
- 3 While DSS Player is running, press F1 on the keyboard.

## Macintosh

While DSS Player is running, select [DSS Player Help] from the [Help] menu.

---

### Note

- Online Help is available after the DSS Player is installed (☞ P.71).

# Connecting Recorder to PC

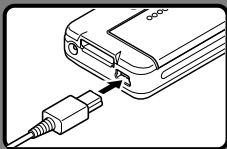
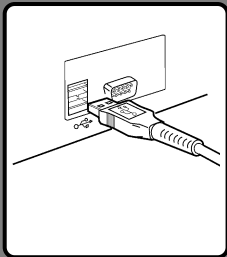

## Connecting to Your PC Using the USB Cable

- 1 Turn ON the recorder (☞ P.22).
- 2 Connect the USB cable to the USB port of the PC.
- 3 Confirm that the recorder has stopped and connect a USB cable to the connection port on the recorder.

If [Remote] is displayed on the recorder, it indicates proper connections.

Once you connect the recorder to your PC, the recorder will be powered through the USB cable. When the AC adapter is connected power will be supplied from the AC adapter.

While PC connection, the SD card and the microSD card are recognized as the respective separate removable disk drive. Furthermore, removable disk drive is added in order of the microSD card and the SD card.

## Supported computers

### Windows

Operating System: Windows 2000/XP/Vista  
Supported computers: Windows computers equipped with more than one free USB port.

### Macintosh

Operating System: Mac OS 10.3.9 - 10.5  
Supported computers: Apple Macintosh series equipped with more than one free USB port.

### Notes

- NEVER remove the card or disconnect the USB cable while the record/play indicator light is flashing. If you do, the data on the card will get destroyed.
- Some PC's may not supply sufficient power and the recorder fails to connect. Refer to your PC User's Manual regarding the USB port on your PC.
- Do not connect the recorder to a PC by using a USB hub. Make sure to connect to a USB port on your PC.
- Make sure to push the cable connector all the way in. Otherwise, the recorder may not operate properly.
- This is an operational environment for saving the files recorded by this recorder to your PC with USB connection.
- Even if operational environment is satisfied, we do not support upgraded OS, the multi-boot environment and self-modified computers.

## Connecting to Your PC Using the Cradle

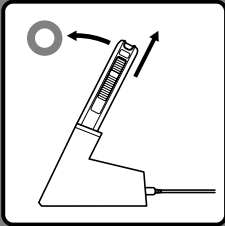
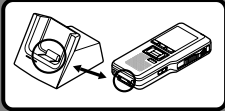
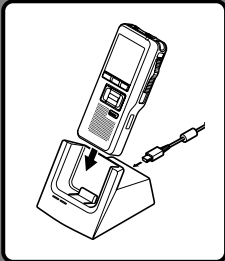

### Place the recorder in the cradle

- 1 Connect the USB cable to the USB port of the PC.
- 2 The USB cable is connected with cradle as shown in figure.
- 3 Turn ON the recorder, then set the recorder in the cradle.  
If [Remote] is displayed on recorder, it indicates proper connection.

### Disconnecting Recorder from PC

To avoid data corruption or loss, make sure that the recorder's record/play indicator light isn't flashing, before removing the recorder from the cradle or disconnect the cable from the recorder terminal.

### Remove the Recorder from the Cradle

To prevent damage or loss of the data, confirm that the recording/playback indicator light of this recorder is not on, and remove this recorder and USB cable from the cradle.

### Notes

- Never touch the contact points at the bottom of the cradle, as that may cause bad connection.
- With a PC connected, the recorder cannot be operated with the foot switch (RS27/28). When connecting the recorder to a PC via the cradle, remove the foot switch.

# Running DSS Player Software

By default, connecting the recorder to your PC, will start the application automatically. Connecting to your PC Using the Cradle.

## Windows

### Disabling Automatic Start

- 1 **Right-click the Device Detector in the System Tray in the lower right-hand corner of the screen, then select [Settings startup application].**
- 2 **Click [DSS Player Pro].**  
The check mark on [DSS Player Pro] disappears.

### Manual Start

- 1 **Start Windows.**
- 2 **Click the [start] button, then select [All Programs].**  
All program menu will be displayed.
- 3 **Select [Olympus DSS Player Pro], then click [Dictation Module].**

## Macintosh

### Disabling Automatic Start

- 1 **Click the Dock's System Preferences.**
- 2 **Click Device Detector.**
- 3 **Turn the automatic startup setting Off.**

### Manual Start

- 1 **Start your Macintosh.**
- 2 **Double click the DSS Player icon for the folder in [Application] → [DSS Player].**  
All program menu will be displayed.
- 3 **Register user information**  
The user's registration screen will be displayed at the time of initial startup. Please input the serial number. Please see the seal attached to the CD-ROM package included with the DSS Player, for the serial number. After the input has ended, click [OK] to complete the registration.

## 5 Other Practical Use Methods

### Using as External Memory of the Computer

---

When the recorder is connected to your PC, it will be recognized on your PC as a removable drive. You can view and access the recorder card from My Computer and download data from the card to your PC using standard windows copy/move and delete commands. You can also upload data from the PC to the card in the recorder in the same way.

#### Example: Copying Data from PC to Card Using Explorer or Finder

---

- 1 Start Windows.**
- 2 Connecting the recorder to your PC.**  
For connection procedure, refer to "Connecting to Your PC Using the USB Cable" (☞ P.74).
- 3 Open Windows Explorer or Finder window.**  
The product's name is displayed.
- 4 Copy the data.**  
While the data are being written or copied, the record/play indicator light on the recorder will flash.
- 5 Unplug the recorder from a computer.**

---

#### Note

- NEVER remove the card or disconnect the USB cable while the record/play indicator lamp is flashing. If you do, the data on the card will get destroyed.

## 6 Other Information

### Alarm Message List

| <b>Message</b>                              | <b>Meaning</b>            | <b>Explanation</b>                                                    | <b>Action</b>                                                                              |
|---------------------------------------------|---------------------------|-----------------------------------------------------------------------|--------------------------------------------------------------------------------------------|
| <b>Battery Low</b>                          | Low battery power         | Battery power is getting low.                                         | Charge the battery Pack or replace with new batteries (☞ P.14-17).                         |
| <b>Power Supply Error Remove Power Plug</b> | Abnormal voltage detected | Voltage outside of the allowable limit has been detected.             | Use the included AC Adapter (☞ P.21).                                                      |
| <b>File Protected</b>                       | Erase-locked              | Attempt to delete a locked file.                                      | Unlock the file (☞ P.50).                                                                  |
| <b>Index Full</b>                           | Index full                | The file is full of index marks (maximum of 32 marks).                | Erase index marks that are no longer required (☞ P.57).                                    |
| <b>Folder Full</b>                          | Folder full               | The folder is full of files (maximum of 200 files).                   | Erase unnecessary files (☞ P.37).                                                          |
|                                             | Maximum number            | The destination folder already has the maximum number of files (200). | Erase unnecessary files (☞ P.37).                                                          |
| <b>Erase Error</b>                          | Erase failure             | An error occurred while erasing.                                      | Erase once again. When an Erase Error occurs format the card                               |
| <b>Card Error</b>                           | Incompatible card         | An incompatible card was inserted.                                    | Insert a compatible card (☞ P.23, 63).                                                     |
| <b>Memory Full</b>                          | Zero remaining memory     | The card has no remaining memory.                                     | Erase files that are no longer required or insert another card.                            |
| <b>Format Error</b>                         | Formatting error          | There was an error while formatting the card.                         | Reformat the card (☞ P.64).                                                                |
| <b>System Error</b>                         | System error              | System error detected in the recorder.                                | This is a malfunction. Contact the place of purchase or Olympus Service Center for repair. |
| <b>Insert Card</b>                          | No card                   | There is no card inserted.                                            | Insert a card (☞ P.23, 63).                                                                |

# Troubleshooting

| <b>Symptom</b>                               | <b>Probable cause</b>                                                                             | <b>Action</b>                                                                              |
|----------------------------------------------|---------------------------------------------------------------------------------------------------|--------------------------------------------------------------------------------------------|
| <b>Nothing appears on the display</b>        | The batteries are not loaded properly.                                                            | Verify polarity is correct (☞ P.16, 17).                                                   |
|                                              | The batteries are dead.                                                                           | Replace with new batteries (☞ P.17).                                                       |
|                                              | The recorder is in power off mode.                                                                | Turn the recorder ON (☞ P.22).                                                             |
| <b>Won't start</b>                           | The recorder is in power off mode.                                                                | Turn the recorder ON (☞ P.22).                                                             |
|                                              | The batteries are dead.                                                                           | Replace with new batteries (☞ P.17).                                                       |
| <b>Unable to record</b>                      | The card does not have enough memory.                                                             | Erase unnecessary files or insert another card (☞ P.23, 37, 63).                           |
|                                              | The card is unformatted.                                                                          | Format the card (☞ P.64).                                                                  |
|                                              | The maximum number of files has been reached.                                                     | Check another folder.                                                                      |
|                                              | The SD card is locked.                                                                            | Unlock the SD card lock (☞ P.12).                                                          |
| <b>No playback tone heard</b>                | The earphone is connected.                                                                        | Unplug the earphones to use the internal speaker.                                          |
|                                              | The volume level is set to 0.                                                                     | Adjust the + (Volume) button.                                                              |
| <b>Unable to erase</b>                       | The file is locked.                                                                               | Unlock the file (☞ P.50).                                                                  |
|                                              | The SD card is locked.                                                                            | Unlock the SD card lock (☞ P.12).                                                          |
| <b>Noise heard during playback</b>           | The recorder was shaken during recording.                                                         | —                                                                                          |
|                                              | The recorder was placed near a cell phone or fluorescent lamp while recording or during playback. | Move the recorder.                                                                         |
| <b>Recording level too low</b>               | The microphone sensitivity is too low.                                                            | Set the microphone sensitivity to Conference mode and try again (☞ P.31).                  |
| <b>Unable to set index marks</b>             | The maximum number of index marks (32) has been reached.                                          | Erase unnecessary index marks (☞ P.57).                                                    |
|                                              | The file is locked.                                                                               | Unlock the file (☞ P.50).                                                                  |
|                                              | The SD card is locked.                                                                            | Unlock the SD card lock (☞ P.12).                                                          |
| <b>Cannot find the recorded voice</b>        | Wrong folder.                                                                                     | Switch to the right folder.                                                                |
|                                              | Switch the recording card.                                                                        | The recorder is recording to another card.                                                 |
| <b>Cannot connect to a PC using a cradle</b> | Sometimes a connection cannot be made with some PCs running Windows XP or Vista.                  | You need to change the PC's USB settings. See DSS Player online help for details (☞ P.73). |

# Accessories

---

**Headset: E62, E102**

Stereo headset for your PC. A helpful tool for PC based transcription.

**Monaural binaural earphone: E20****Noise-cancellation microphone: ME12 (Dictation microphone)**

Used to get crisp recordings of your own voice by reducing the effects of ambient noise. Recommended to improve the accuracy when using voice-recognition software.

**External microphone: ME15**

A lavalier omnidirectional microphone that clips to clothing. Used to record your own voice or people near you.

**PC transcription kit: AS-5000**

The AS-5000 transcription kit provides you with a PC-footswitch, a headset and DSS Player Pro Transcription Module for easy transcription of DSS recordings.

**Foot switch: RS27/28**

Connect to the USB cradle with DS-5000/DS-5000iD for hands-free transcription.

**Connecting cord: KA333**

Use to connect the microphone jack of this unit to a radio or other sound source.

**Telephone pickup: TP7**

Earphone type microphone can be plugged into your ear while phoning. The voice or conversation over the phone can be clearly recorded.

**Ni-MH rechargeable battery: BR403**

High-efficiency rechargeable long life batteries.

**Highly sensitive noise-cancellation monaural microphone: ME52W**

This microphone is used to record sound at a distance while minimizing surrounding noise.



# Specifications

---

## **Recording format**

DS2 (Digital Speech Standard Pro)

## **Recording media**

micro SD, SD-card: 512 MB to 8 GB

## **Input level** -70 dBv

## **Sampling frequency**

QP mode: 16 kHz

SP mode: 12 kHz

## **Overall frequency response**

QP mode: 200 to 7,000 Hz

SP mode: 200 to 5,000 Hz

## **Recording time (512 MB Card)**

QP mode: 38 hours 45 minutes

SP mode: 79 hours 30 minutes

## **Alkaline battery life**

### **Recording:**

QP mode: Approx. 24 hours

SP mode: Approx. 32 hours

### **Playback:**

All mode: Approx. 13 hours

## **Ni-MH Rechargeable Battery life**

### **Recording:**

QP mode: Approx. 20 hours

SP mode: Approx. 28 hours

### **Playback:**

All mode: Approx. 10 hours

## **Speaker**

Built-in ø23mm round dynamic speaker

## **MIC/EAR jack**

ø3.5 mm mini-jack, impedance

MIC 2 kΩ, EAR 8 Ω or more

## **Maximum working output (3 V DC)**

250 mW or more (8 Ω speaker)

## **Input power requirement**

Rated voltage: 5 V

Batteries: Ni-MH Rechargeable Battery Pack or Two AAA batteries (LR03 or R03) or Two Ni-MH rechargeable batteries

## **External dimensions**

113.5 x 50.0 x 17 mm

(without protrusions)

## **Weight**

110 g (Including Ni-MH Rechargeable Battery Pack)

\* Specifications and design are subject to change without notice.

\* Battery life is measured by Olympus. It varies greatly according to the type of batteries used and the conditions of use.

# Technical Assistance and Support

---

DS-5000 is part of the Olympus Professional Dictation System. Your dealer is trained to troubleshoot and fix many common problems that you may be having with this system. If you encounter problems using your DS-5000/DS-5000iD, we recommend that you contact your Olympus Professional Dealer that sold you the system. If your dealer cannot fix your problem, please call our technical hotline number or send an E-mail.

- ◆ For customers in the U.S. and Canada  
Phone: 1-888-553-4448  
E-mail: [distec@olympus.com](mailto:distec@olympus.com)
- ◆ For customers in Europe  
E-mail : [dss.support@olympus-europa.com](mailto:dss.support@olympus-europa.com)

# OLYMPUS®

## OLYMPUS IMAGING CORP.

Shinjuku Mondolith, 3-1 Nishi-Shinjuku 2-chome, Shinjuku-ku, Tokyo 163-0914, Japan. Tel. 03-3340-2111

## OLYMPUS IMAGING AMERICA INC.

3500 Corporate Parkway, P.O.Box 610, Center Valley, PA 18034-0610, U.S.A. Tel. 1-888-553-4448

## OLYMPUS IMAGING EUROPA GMBH

(Premises/Goods delivery) Wendenstrasse 14-18, 20097 Hamburg, Germany. Tel. 040-237730

(Letters) Postfach 10 49 08, 20034 Hamburg, Germany.

## OLYMPUS UK LTD.

Vision House 19 Colonial Way Watford Herts WD24 4JL London EC1Y 0TX, Tel. +44(0) 1923 831000

<http://www.olympus.com>

## For customers in North and South America

### *Declaration of Conformity*

|                    |                                                                               |
|--------------------|-------------------------------------------------------------------------------|
| Model Number:      | DS-5000/DS-5000iD                                                             |
| Trade Name:        | DIGITAL VOICE RECORDER                                                        |
| Responsible Party: | OLYMPUS IMAGING AMERICA INC.                                                  |
| Address:           | 3500 Corporate Parkway, P.O. Box 610, Center Valley, PA 18034-0610,<br>U.S.A. |
| Telephone Number:  | 1-888-553-4448                                                                |

This device Complies with Part 15 of the FCC Rules. Operation is subject to the following two conditions: (1) This device may not cause harmful interference, and (2) this device must accept any interference received, including interference that may cause undesired operation.

 Tested To Comply  
With FCC Standards  
FOR HOME OR OFFICE USE

## Canadian RFI

This digital apparatus does not exceed the Class B limits for radio noise emissions from digital apparatus as set out in the Radio Interference Regulations of the Canadian Department of Communications.

Cet appareil numérique ne dépasse pas les limites de Catégorie B pour les émissions de bruit radio émanant d'appareils numériques, tel que prévu dans les Règlements sur l'Interférence Radio du Département Canadien des Communications.

## For customers in Europe



"CE" mark indicates that this product complies with the European requirements for safety, health, environment and customer protection.



This symbol [crossed-out wheeled bin WEEE Annex IV] indicates separate collection of waste electrical and electronic equipment in the EU countries. Please do not throw the equipment into the domestic refuse. Please use the return and collection systems available in your country for the disposal of this product.

Applicable Product : DS-5000/DS-5000iD, AC adapter, Cradle

P2-BS0038-02  
AP0803